



Kits e Reparos de Caixa e Bomba de
Direção Hidráulica
versão 2016

APC

A MARCA DA QUALIDADE

Índice

| | |
|-------------------------|----|
| Kit Ferramenta Especial | 04 |
| Agrale | 05 |
| Alfa Romeo | 05 |
| Asia Motors | 05 |
| Audi | 06 |
| BMW | 06 |
| Chery | 07 |
| Chevrolet | 07 |
| Chrysler | 10 |
| Citroën | 10 |
| Daewoo - Saab | 11 |
| Dodge | 11 |
| Fiat | 12 |
| Ford | 13 |
| Honda | 16 |
| Hyundai | 17 |
| Iveco | 18 |
| Jeep | 19 |
| Kia | 19 |
| Land Rover | 20 |
| Lexus | 20 |
| Mazda | 20 |
| Mercedes | 21 |
| Mitsubishi | 23 |
| Nissan | 24 |
| Peugeot | 24 |
| Renault | 25 |
| Scania | 26 |
| Subaru | 27 |
| Suzuki | 27 |
| Toyota | 28 |
| Troller | 29 |
| Volkswagen | 29 |
| Volvo | 31 |
| Problemas x Causas | 55 |

Kit Ferramenta Especial



| Cód. AGEL | Ref. Mercado | Aplicação | Coifas | Buchas | Página |
|-----------|-----------------|--|--------|--------|--------|
| CX.22001 | ZF.7863.698.001 | Rep. BBA. Agrale Volare 7500 / 8500 / FN4 | | | 46 |
| CX.22032 | ZF.7673.698.032 | Rep. BBA. Agrale Netuno 4T / Puma | | | 46 |
| CX.33255 | ZF.8090.698.255 | Rep. CX. Agrale 7000 / 7500 / 8500 / Volare A6 / A8 / Puma 914 | | | 46 |

Alfa Romeo

| Cód. AGEL | Ref. Mercado | Aplicação | Coifas | Buchas | Página |
|------------|-----------------|--|--------|--------|--------|
| CX.22005 | ZF.7681.698.258 | Rep. BBA Alfa Romeo 164 (Cód. Bomba 7681.955.253) | | | 46 |
| CX.33040 | TRW | Rep. CX. Alfa Romeo Spider (96 a 00) / GTV (95 a 97) | X | X | 46 |
| CX.33040/2 | TRW | Rep. CX. Alfa Romeo Spider (96 a 00) / GTV (95 a 97) | | X | 46 |
| CX.33042 | TRW | Rep. CX. Alfa Romeo 145 / 146 (94 a 99) | X | X | 46 |
| CX.33042/2 | TRW | Rep. CX. Alfa Romeo 145 / 146 (94 a 99) | | X | 46 |
| CX.33751/2 | TRW | Rep. CX. Alfa Romeo 164 | | X | 46 |

CX.33000 - TRW/DHB - Kit Ferramenta Especial para Montagem - Direção Hidráulica - Linha Leve

Praticidade para o aplicador, segurança e bem-estar para o usuário

Medidas da Maleta: 24 x 40 x 9cm (Sujeito a disponibilidade de estoque. Consulte o depto. de vendas)

Asia Motors

| Cód. AGEL | Ref. Mercado | Aplicação | Coifas | Buchas | Página |
|------------|--------------|--|--------|--------|--------|
| CX.22300 | KIO | Rep. BBA. Asia Topic (Retentor 20mm) | | | 39 |
| CX.33019 | JAPAN | Rep. CX. Asia Topic (Vedação da Gaxeta NPSK-ORPU-0050) | X | | 46 |
| CX.33116 | TRW | Rep. CX. Asia Topic após 94 | X | | 46 |
| CX.33116/2 | TRW | Rep. CX. Asia Topic após 94 | | | 46 |

Audi

| Cód. AGEL | Ref. Mercado | Aplicação | Coifas | Buchas | Página |
|------------|---------------------|---|--------|--------|--------|
| CX.22004 | ZF | Rep. BBA. Audi A6/A6 Quattro (92 a 97) / A8 / A8 Quattro (97 a 98) | | | 46 |
| CX.22700 | ZF.7681.633.003 | Rep. BBA. Audi | | | 32 |
| CX.33006 | ZF.7881.955.319 | Rep. CX. Audi A80 (86 a 94) / A90 (93 a 95) / Audi S2 (ZF.7881.955.313) | X | X | 46 |
| CX.33010 | ZF | Rep. CX. Audi TT após 98 (Cremalheira 24MM.) | X | | 32 |
| CX.33010/2 | ZF | Rep. CX. Audi TT após 98 (Cremalheira 24MM.) | | | 32 |
| CX.33014/2 | ZF.7852.974.336 | Rep. CX. Audi A4-1.6 / 1.8 / 1.8T / Quattro 95 | | | 32 |
| CX.33016/2 | ZF.7847.991.533 | Rep. CX. Audi 100 / 200 / 5000 (1992) / A6 | | X | 32 |
| CX.33035/2 | ZF | Rep. CX. Audi 80 / 90 - 100 (90 a 94) (Cód. Caixa 7847.955.238/244) Rep. CX. Audi A6 (94 a 98) / Audi 5000 (Cód. Caixa 7847.955.229) | | | 32 |
| CX.33078/2 | ZF.7852.993.108/110 | Rep. CX. Audi A8 | | | 46 |
| CX.33086/2 | ZF | Rep. CX. Audi A6 (Cód. Caixa 7852.993.172/210/211/232/233) | | | 46 |
| CX.33087/2 | ZF.7852.993.178 | Rep. CX. Audi A6 | | | 46 |
| CX.33096 | ZF.7852.974.393/489 | Rep. CX. Audi A4 | | | 32 |
| CX.33098 | ZF.7852.991.151 | Rep. CX. Audi A8 (Cód. Caixa 7852.991.151/152/160) | | | 46 |
| CX.33099 | ZF.7852.993.145 | Rep. CX. Audi A6 | | | 47 |
| CX.33953 | ZF.7891.633.501 | Rep. CX. Audi A3 após 98 | X | X | 33 |
| CX.33953/2 | ZF.7891.633.501 | Rep. CX. Audi A3 após 98 | | X | 33 |
| CX.33954/2 | KOYO / SMI | Rep. CX. Audi A4 (94 A 00) | | | 47 |

BMW (+)

| Cód. AGEL | Ref. Mercado | Aplicação | Coifas | Buchas | Página |
|------------|---------------------|---|--------|--------|--------|
| CX.22015 | LUK.LH - 1.137.951 | Rep. BBA. BMW Série 300 / 500 | | | 33 |
| CX.22051 | KYB / ZF | Rep. BBA. BMW Série 300 (Eixo 15MM.) (99 a 02) | | | 47 |
| CX.22958 | ZF | Rep. BBA. BMW Série 300 / 500 / 700 após 88 | | | 33 |
| CX.33008/2 | ZF.7852.955.229 | Rep. CX. BMW Série 3 (92 a 95) | | | 33 |
| CX.33009/2 | ZF | Rep. CX. BMW Série 5 após 96 (c/ ou s/ Servotronic 28MM.) | | | 33 |
| CX.33011 | ZF.7852.955.227/306 | Rep. CX. BMW Série (E36) com coifas | X | | 33 |
| CX.33011/2 | ZF.7852.955.227/306 | Rep. CX. BMW Série (E36) sem coifas | | | 33 |

(+ BMW)

| Cód. AGEL | Ref. Mercado | Aplicação | Coifas | Buchas | Página |
|------------|-------------------------------|---|--------|--------|--------|
| CX.33018 | ZF.8052.955.172 | Rep. CX. BMW S-540 (1980...) ST FIM. | | | 47 |
| CX.33025/2 | TRW | Rep. CX. BMW Z-3 (96 a 01) / 323 (00) (Cremalheira 28MM.) | | | 33 |
| CX.33076/2 | ZF.7852.993.419/760 | Rep. CX. BMW X5 | | | 47 |
| CX.33077/2 | ZF | Rep. CX. BMW 745i (E65) (Cód. Caixa 7852.993.229/269/402/403/536) | | | 47 |
| CX.33088/2 | ZF | Rep. CX. BMW X5 (Cód. Caixa 7852.974.553/554/560/561/775/880) | | | 47 |
| CX.33091 | ZF.7852.993.167 | Rep. CX. BMW 526i / 528i / 540i | | | 47 |
| CX.33092 | ZF.7852.955.223/224 | Rep. CX. BMW | | | 33 |
| CX.33093 | ZF.7852.955.278 | Rep. CX. BMW 526 / 528 / 540 | | | 47 |
| CX.33094/2 | ZF.7852.974.490 / 981/678/712 | Rep. CX. BMW 320 / 325 / 330 / 328 | | | 33 |
| CX.33096 | ZF.7852.974.393/489 | Rep. CX. BMW | | | 32 |
| CX.33097 | ZF.7852.991.157/149 | Rep. CX. BMW 528i | | | 33 |

Chery

| Cód. AGEL | Ref. Mercado | Aplicação | Coifas | Buchas | Página |
|------------|--------------|-------------------------------|--------|--------|--------|
| CX.33127 | | Rep. CX. Tiggo STL com coifas | X | | 47 |
| CX.33127/2 | | Rep. CX. Tiggo STL sem coifas | | | 47 |

Chevrolet (+)

| Cód. AGEL | Ref. Mercado | Aplicação | Coifas | Buchas | Página |
|-----------|-----------------|--|--------|--------|--------|
| CX.22001 | ZF.7683.698.001 | Rep. BBA. Silverado / D40 Maxion FN4 | | | 46 |
| CX.22003 | BOMBA TC 17MM. | Rep. BBA. Corvette (97 a 03) / Lumina (Motor 3.1) | | | 33 |
| CX.22021 | BOMBA KYB | Rep. BBA. Captiva 08... | | | 47 |
| CX.22022 | ZF.7673.698.022 | Rep. BBA. (ZF 125) A-C40 | | | 33 |
| CX.22023 | ZF.7673.698.023 | Rep. BBA. (ZF 908) D-20 / ACD 10 / Bonanza | | | 33 |
| CX.22028 | ZF.7673.698.028 | Rep. BBA. Opala / ACD 10 / Veraneio / Bonanza / Caravan (Caneco) | | | 33 |
| CX.22077 | DHB 1.804.077 | Rep. BBA. Monza / Kadet até 89 | | | 34 |

(+) Chevrolet (+)

| Cód. AGEL | Ref. Mercado | Aplicação | Coifas | Buchas | Página |
|------------|----------------------|--|--------|--------|--------|
| CX.22090 | LUK | Rep. BBA. Blazer / S-10 após 00 (Bomba acoplada com bomba vácuo) | | | 34 |
| CX.22103 | BOMBA TC 19MM. | Rep. BBA. Omega 3.0 / Suprema (93 a 98) | | | 34 |
| CX.22107 | SAGINAW | Rep. BBA. C10 / C14 / D20 (Bomba com reservatório acoplado) Rep. BBA. S10 / Blazer (Motor V6) (Reservatório acoplado) | | | 34 |
| CX.22176 | ZF. 7672.698.176 | Rep. BBA. Opala / Caravan / ACD 10 após 85 | | | 34 |
| CX.22249 | ZF. 7691.698.001 | Rep. BBA. S-10 / Blazer 95... / Omega / Suprema (93 a 98) | | | 34 |
| CX.22304 | DHB 1.804.304 | Rep. BBA. Montana PickUp 03... / Corsa / PickUp / Wagon 94... Rep. BBA. Monza / Kadet / Ipanema 90... / Lumina 3.8L 92 a 94 | | | 34 |
| CX.22305 | DHB 1804.305 | Rep. BBA. S-10 / Ranger / Sprinter DHB Reversa | | | 47 |
| CX.22800 | ZF. 7683.298.800 | Rep. BBA. Silverado MWM | | | 34 |
| CX.33012 | SAGINAW | Rep. CX. Corvette (84 a 96) | X | X | 34 |
| CX.33012/2 | SAGINAW | Rep. CX. Corvette (84 a 96) | | X | 34 |
| CX.33013/2 | ZF. 7836.974.160/193 | Rep. CX. Astra / Calibra / Vectra (94 a 96) | | | 34 |
| CX.33015 | ZF. 8053.698.015 | Rep. CX. Opala / Caravan / ACD10 / D20 / Veraneio / Bonanza (74 a 84) | | | 35 |
| CX.33031 | SAGINAW / DHB | Rep. CX. Lumina (Van 90 a 99) / Lumina (Automóvel 94 a 03) | X | X | 34 |
| CX.33049 | DHB 1.804.049 | Rep. CX. Astra s/ ar após 99 | X | X | 34 |
| CX.33049/2 | DHB 1.804.049 | Rep. CX. Astra s/ ar após 99 | | X | 34 |
| CX.33062/2 | DHB 1.804.062 | Rep. CX. Monza / Kadet até 90 | | | 35 |
| CX.33070 | TRW | Rep. CX. Astra após 99... (com bomba elétrica) | X | X | 35 |
| CX.33070/2 | TRW | Rep. CX. Astra após 99... (com bomba elétrica) | | X | 35 |
| CX.33071 | TRW | Rep. CX. Zafira após 01... (com bomba elétrica) | X | X | 35 |
| CX.33071/2 | TRW | Rep. CX. Zafira após 01... (com bomba elétrica) | | X | 35 |
| CX.33089 | SAGINAW / DHB | Rep. CX. Blazer / S10 (95 a 98) / (Setor 32MM) c/ Junta | | | 35 |
| CX.33090 | SAGINAW / DHB | Rep. CX. Blazer / Suburban / S10 após 99 (Setor 35,50MM.) C/ Junta | | | 36 |
| CX.33100 | DHB 1.804.100 | Rep. CX. Monza / Ipanema / Kadet 90... / Astra / Calibra / Vectra(94 a 96) | X | | 35 |
| CX.33100/2 | DHB 1.804.100 | Rep. CX. Monza / Ipanema / Kadet 90... / Astra / Calibra / Vectra(94 a 96) | | | 35 |
| CX.33101 | ZF. 8053.698.013 | Rep. Sem Fim C10 / D20 / D40 | | | 35 |
| CX.33107 | ZF. 7891.633.002 | Rep. CX. Vectra (Opel 97 a 05) com coifas | X | X | 35 |
| CX.33107/2 | ZF. 7891.633.002 | Rep. CX. Vectra (Opel 97 a 05) sem coifas | | X | 35 |

(+) Chevrolet

| Cód. AGEL | Ref. Mercado | Aplicação | Coifas | Buchas | Página |
|------------|----------------------|---|--------|--------|--------|
| CX.33108 | SAGINAW / DHB | Rep. CX. Blazer / S10 (Setor 32 e 35,5MM.) c/ Junta | | | 36 |
| CX.33112 | KOYO / BENDIX | Rep. CX. Space-Van (Ret. Cremalheira com aba) | X | | 35 |
| CX.33112/2 | KOYO / BENDIX | Rep. CX. Space-Van (Ret. Cremalheira com aba) | | | 35 |
| CX.33122 | DHB 1.804.122 | Rep. CX. D11000 a 22000 após 83 (2 Pistões) | | | 34 |
| CX.33130 | DHB 1.804.130 | Rep. CX. D20 / D40 / A20 / C10 / Silverado Nac. após 85 c/ junta | | | 35 |
| CX.33140 | SMI / KOYO | Rep. CX. Space-Van (Ret. Cremalheira sem aba) | X | | 43 |
| CX.33140/2 | SMI / KOYO | Rep. CX. Space-Van (Ret. Cremalheira sem aba) | | | 43 |
| CX.33143 | DHB 1.804.143 | Rep. CX. Vectra (96 a 05) / Zafira após 02 | X | X | 35 |
| CX.33143/2 | DHB 1.804.143 | Rep. CX. Vectra (96 a 05) / Zafira após 02 | | X | 35 |
| CX.33166 | Rep.Cx.Agile após 10 | Rep. CX. Prisma / Celta / Agile após 10... com coifas | X | X | 45 |
| CX.33166/2 | Rep.Cx.Agile após 10 | Rep. CX. Prisma / Celta / Agile após 10... sem coifas | | X | 45 |
| CX.33167 | Rep. Cx. Captiva | Rep. CX. Captiva Bucha Reta após 08... Retentor 48mm com coifas | X | X | 45 |
| CX.33167/2 | Rep. Cx. Captiva | Rep. CX. Captiva Bucha Reta após 08... Retentor 48mm sem coifas | | X | 45 |
| CX.33168 | Rep. Cx. Captiva | Rep. CX. Captiva Bucha Cônica após 08... com coifas | X | X | 45 |
| CX.33168/2 | Rep. Cx. Captiva | Rep. CX. Captiva Bucha Cônica após 08... sem coifas | | X | 45 |
| CX.33169 | DHB 1.804.169 | Rep. CX. Corsa (94 a 02) / Tigra (94 a 01) / Celta após 00 | X | X | 34 |
| CX.33169/2 | DHB 1.804.169 | Rep. CX. Corsa (94 a 02) / Tigra (94 a 01) / Celta após 00 | | X | 34 |
| CX.33171/2 | KYB | Rep. CX. KYB Omega Fittipaldi 2007... | | | 47 |
| CX.33179 | ZF. 8053.698.179 | Rep. CX. Opala / Caravan (85 a 90) | | | 35 |
| CX.33186 | DHB 1.804.186 | Rep. CX. Astra após 02 / Vectra após 05 | X | X | 37 |
| CX.33186/2 | DHB 1.804.186 | Rep. CX. Astra após 02 / Vectra após 05 | | X | 37 |
| CX.33210 | ZF. 8053.698.210 | Rep. CX. D20 / D40 / Bonanza / Veraneio / A-10 (85 a 90) | | | 35 |
| CX.33235 | ZF. 8053.698.235 | Rep. CX. Opala / Silverado / Veraneio / D20 / Bonanza após 90 (Servotronic) | | | 35 |
| CX.33251 | ZF. 8052.698.251 | Rep. CX. Omega / Suprema (93 a 98) | | | 35 |
| CX.33252/2 | TRW | Rep. CX. Omega Australiano após 99 | | X | 47 |
| CX.33827 | DHB 1.804.485/486 | Rep. CX. Corsa / Meriva / Montana após 02 | X | X | 34 |
| CX.33827/2 | DHB 1.804.485/486 | Rep. CX. Corsa / Meriva / Montana após 02 | | X | 34 |
| CX.33828 | DHB 1.804.486 | Rep. CX. Corsa / Meriva / Montana 06... coifa com respiro | X | X | 47 |
| CX.33828/2 | DHB 1.804.486 | Rep. CX. Corsa / Meriva / Montana 06... sem coifa | | X | 47 |

Chrysler

| Cód. AGEL | Ref. Mercado | Aplicação | Coifas | Buchas | Página |
|------------|------------------|---|--------|--------|--------|
| CX.22054 | ZF | Rep. BBA. Chrysler Caravan / Grand Caravan (90 a 91) / Town & Country Rep. BBA. Chrysler Caravan ES (88 a 91) / Lebaron / GTS (88 a 91) Rep. BBA. Chrysler Limousine (88 a 91) / Maserati (88 a 91) | | | 36 |
| CX.22107 | SAGINAW | Rep. BBA. Chrysler Caravan / Gran Caravan (85 a 98) | | | 34 |
| CX.22932 | KOYO | Rep. BBA. Chrysler Neon (97 a 00) | | | 48 |
| CX.33145/2 | CX. TRW | Rep. PT Cruiser 02 a 06 sem coifa | | | 48 |
| CX.33147/2 | TRW | Rep. CX. Chrysler Caravan / Grand Caravan (96 a 98) / Neon (95 a 01) | | | 36 |
| CX.33148/2 | CX. TRW | Rep. CX. Stratus / Neon / 95 a 98 / Caravan 96 a 98 sem coifa | | | 48 |
| CX.33247/2 | Cruiser CX. Imp. | Rep. Neon após 00... CX. Importada PT Cruiser 02 a 03 | | | 48 |

Citroën (+)

| Cód. AGEL | Ref. Mercado | Aplicação | Coifas | Buchas | Página |
|------------|------------------|--|--------|--------|--------|
| CX.22001 | ZF. 7863.698.001 | Rep. BBA. Citroën Jumper após 01 | | | 46 |
| CX.22003 | BOMBA TC 17MM. | Rep. BBA. Citroën Berlingo / Xsara / Picasso após 96 / ZX após 94 | | | 33 |
| CX.22049 | ZF | Rep. BBA. Citroën ZX após 94 (Eixo 19MM.) | | | 48 |
| CX.22054 | ZF | Rep. BBA. Citroën Evasion (95 a 00) | | | 36 |
| CX.22103 | BOMBA TC 19MM. | Rep. BBA. Citroën Berlingo / Xsara / Picasso após 96 / ZX após 94 | | | 34 |
| CX.22802 | ZF. 7683.298.802 | Rep. BBA. Citroën Jumper (Cód. BBA. 7683.955.114/911/926) | | | 36 |
| CX.33150 | TRW | Rep. Válvula Citroën Berlingo / Xantia / Saxo após 96 Rep. Válvula Citroën Xsara / Picasso após 99 / ZX após 94 | X | | 36 |
| CX.33152 | ZF | Rep. Válvula Citroën ZX (95 a 98) (Coifas iguais) | X | | 44 |
| CX.33153 | ZF | Rep. Válvula Citroën Picasso / Xsara após 99 (Ret.Inf.Ext. 43 e 47MM.) Rep. Válvula Citroën Berlingo após 96 / Xantia (Ret.Inf.Ext. 43 e 47MM.) Rep. Válvula Citroën ZX / XM após 94 (Ret.Inf.Ext. 43 e 47MM.) | X | | 36 |
| CX.33156 | TRW | Rep. CX. Citroën Synergie (94 a 02) / Citroën Evasion (94 a 02) | X | | 36 |
| CX.33156/2 | TRW | Rep. CX. Citroën Synergie (94 a 02) / Citroën Evasion (94 a 02) | | | 36 |

(+) Citroën

| Cód. AGEL | Ref. Mercado | Aplicação | Coifas | Buchas | Página |
|------------|--------------|--|--------|--------|--------|
| CX.33157 | ZF.Z8-X4 | Rep. CX. Citroën C5 (01 A 07) (Cód. Caixa Z8-X4) | X | | 48 |
| CX.33940 | TRW | Rep. CX. Jumper | X | | 37 |
| CX.33940/2 | TRW | Rep. CX. Jumper | | X | 37 |

Daewoo - Saab

| Cód. AGEL | Ref. Mercado | Aplicação | Coifas | Buchas | Página |
|------------|------------------|--|--------|--------|--------|
| CX.33013/2 | ZF. 7536.633.007 | Rep. CX. Saab 900 (93 a 98) | | | 34 |
| CX.33031 | SAGINAW / DHB | Rep. CX. Daewoo Nubira | X | | 34 |
| CX.33100/2 | DHB 1.804.100 | Rep. CX. Daewoo Espero Rep. CX. Saab 900 (93 a 98) / Saab (98 a 02) | | | 35 |

Dodge

| Cód. AGEL | Ref. Mercado | Aplicação | Coifas | Buchas | Página |
|------------|----------------|--|--------|--------|--------|
| CX.22054 | ZF | Rep. BBA. Dodge Aries / Daytona (88 a 89) / Dynasty (90 a 91) | | | 36 |
| CX.22101 | HDB / KOYO | Rep. BBA. Dodge Ram 1500/2500/3500 (Reservatório acoplado do lado) | | | 36 |
| CX.22107 | SAGINAW | Rep. BBA. Dodge Dakota (97 a 03) Exceto 4.7L | | | 34 |
| CX.33050 | FORD Importado | Rep. CX. Dodge Ram 1500/2500/3500 (03 a 08) (Setor 35MM.) | | | 36 |
| CX.33085 | DHB | Rep. CX. Dodge Ram 1500/2500/3500 (94 a 98) | | | 36 |
| CX.33147/2 | TRW | Rep. CX. Dodge Caravan / Mini Ram (96 a 98) | | | 36 |
| CX.33149/2 | TRW | Rep. CX. Aries / Daytona / Lancer (81 a 95) / Dynasty (88 a 93) | | | 36 |

Fiat (+)

| Cód. AGEL | Ref. Mercado | Aplicação | Coifas | Buchas | Página |
|------------|------------------|--|--------|--------|--------|
| CX.22001 | ZF. 7683.698.001 | Rep. BBA. Fiat Ducato (Alumínio) | | | 46 |
| CX.22023 | ZF. 7673.698.023 | Rep. BBA. (ZF 908) 190 - 190H | | | 33 |
| CX.22103 | BOMBA TC 19MM | Rep. BBA. Tempra / Tempra SW (93 a 98) / Tipo 94 a 96 | | | 34 |
| CX.22249 | ZF. 7691.698.249 | Rep. BBA. Tipo (94 a 96) / Tempra (93 a 98) | | | 34 |
| CX.22304 | DHB 1.804.304 | Rep. BBA. Prêmio / Elba / Uno / Fiorino / Tempra | | | 34 |
| CX.22602 | ZF. 8695.633.003 | Rep. BBA. ZF. Ducato Nova 12... | | | 48 |
| CX.22802 | ZF. 7683.298.802 | Rep. BBA. Fiat Ducato | | | 36 |
| CX.33017 | ZF. 8065.698.017 | Rep. CX. 190 e 190H / 619 / 697 / Villares | | | 37 |
| CX.33109 | TRW ITALIANA | Rep. CX. Fiat Marea / Marea Weekend / Brava (95 a 02) / Tempra SW | X | X | 36 |
| CX.33109/2 | TRW ITALIANA | Rep. CX. Fiat Marea / Marea Weekend / Brava (95 a 02) / Tempra SW | | X | 36 |
| CX.33110 | TRW 37.502.239 | Rep. CX. Tipo 2.0 (94 a 96) / Tempra SW (93 a 98) Italiana Serial nº37502239 | X | X | 36 |
| CX.33110/2 | TRW 37.502.239 | Rep. CX. Tipo 2.0 (94 a 96) / Tempra SW (93 a 98) Italiana Serial nº37502239 | | X | 36 |
| CX.33111 | TRW 37.502.253 | Rep. CX. Tipo 1.6 (94 a 98) Italiana Serial nº 37502253 | X | X | 37 |
| CX.33111/2 | TRW 37.502.253 | Rep. CX. Tipo 1.6 (94 a 98) Italiana Serial nº 37502253 | | X | 37 |
| CX.33199 | DHB. 1.804.199 | Rep. CX. Tempra / Elba / Uno / Prêmio após 94 | X | X | 37 |
| CX.33199/2 | DHB. 1.804.199 | Rep. CX. Tempra / Elba / Uno / Prêmio após 94 | | X | 37 |
| CX.33736 | TRW.16.150.736 | Rep. CX. Palio / Palio Weekend (96 a 01 antiga) | X | X | 37 |
| CX.33736/2 | TRW.16.150.736 | Rep. CX. Palio / Palio Weekend (96 a 01 antiga) | | X | 37 |
| CX.33758 | TRW 16.150.758 | Rep. CX. Tempra / Elba / Prêmio / Uno...94 | X | X | 37 |
| CX.33758/2 | TRW 16.150.758 | Rep. CX. Tempra / Elba / Prêmio / Uno...94 | | X | 37 |
| CX.33760 | TRW 16.150.760 | Rep. CX. Tempra / Uno após 95 | X | X | 37 |
| CX.33760/2 | TRW 16.150.760 | Rep. CX. Tempra / Uno após 95 | | X | 37 |
| CX.33844 | TRW 16.150.844 | Rep. CX. Palio / Doblò / Idea / Strada / Siena após 01 (Motor Fire) | X | X | 37 |
| CX.33844/2 | TRW 16.150.844 | Rep. CX. Palio / Doblò / Idea / Strada / Siena após 01 (Motor Fire) | | X | 37 |
| CX.33845 | TRW 51783036 | Rep. CX. Punto 08... Serial nº 51783036 | X | X | 48 |
| CX.33845/2 | TRW 51783036 | Rep. CX. Punto 08... Serial nº 51783036 | | X | 48 |
| CX.33847 | JTEKT | Rep. CX. Palio / Siena / Uno 2008... com coifas | X | X | 48 |
| CX.33847/2 | JTEKT | Rep. CX. Palio / Siena / Uno 2008... sem coifas | | X | 48 |

(+ Fiat

| Cód. AGEL | Ref. Mercado | Aplicação | Coifas | Buchas | Página |
|------------|--------------|--|--------|--------|--------|
| CX.33940 | TRW | Rep. CX. Ducato após 95 | X | X | 37 |
| CX.33940/2 | TRW | Rep. CX. Ducato após 95 | | X | 37 |
| CX.33943 | TRW | Rep. CX. Ducato após 2010 (Caixa Blindada) | X | | 43 |
| CX.33943/2 | TRW | Rep. CX. Ducato após 2010 (Caixa Blindada) | | | 43 |

Ford (+)

| Cód. AGEL | Ref. Mercado | Aplicação | Coifas | Buchas | Página |
|-----------|------------------|---|--------|--------|--------|
| CX.22001 | ZF. 7683.698.001 | Rep. BBA. F 12000 / 14000 / Cargo / 814 / B1618 (FN 4) | | | 46 |
| CX.22022 | ZF. 7673.698.022 | Rep. BBA. (ZF 125) F1000 a F4000 até 89 | | | 33 |
| CX.22029 | ZF. 7673.698.029 | Rep. BBA. F7000 a F22000 até 89 | | | 37 |
| CX.22052 | FORD | Rep. BBA. Focus após 00 | | | 48 |
| CX.22054 | ZF | Rep. BBA. Maverick após 93 / Scorpio (86 a 89) | | | 36 |
| CX.22059 | REP. BBA. FUSION | Rep. BBA. Fusion 08... com reservatório acoplado | | | 48 |
| CX.22100 | FORD | Rep. BBA. Aerostar (86 a 97) / Excursion (Diesel 7.3L - 00 a 02) Rep. BBA. Expedition (Diesel 7.3L - 97 a 02) / Explorer Gasolina 93... Rep. BBA. F250 (97 a 97) / Landau / Galaxie / Taurus 3.0L 12V (92 a 00) Rep. BBA. Windstar (95 a 98) / Ranger Gasolina após 93 | | | 37 |
| CX.22101 | HBD / KOYO | Rep. BBA. Courier 98... / Escort / Verona 97... Rep. BBA. Fiesta / KA / Mondeo (92 a 02) | | | 36 |
| CX.22103 | BOMBA TC 19MM. | Rep. BBA. Explorer / Ranger após 93 Diesel | | | 34 |
| CX.22176 | ZF. 7672.698.176 | Rep. BBA. F1000 a F4000 após 90 | | | 34 |
| CX.22194 | ZF. 7671.698.194 | Rep. BBA. Del Rey / Belina / Pampa / Scala (84 a 96) Rep. BBA. Versailles / Royale (92 a 96) | | | 37 |
| CX.22207 | ZF. 7674.698.207 | Rep. BBA. Cargo - 16170/16210 | | | 37 |
| CX.22249 | ZF. 7691.698.249 | Rep. BBA. Escort / Verona | | | 34 |
| CX.22304 | DHB 1.804.304 | Rep. BBA. F1000 a F4000 / Ecosport / Fiesta | | | 34 |

(+) Ford (+)

| Cód. AGEL | Ref. Mercado | Aplicação | Coifas | Buchas | Página |
|------------|------------------|--|--------|--------|--------|
| CX.22800 | ZF. 7683.298.800 | Rep. BBA. F250 / 350 / 1000 MWM | | | 34 |
| CX.22801 | ZF. 7683.298.801 | Rep. BBA. F250 / 350 / 1000 CUMMINS | | | 37 |
| CX.33017 | ZF. 8065.298.017 | Rep. CX. Servocom ZF | | | 37 |
| CX.33030 | ZF. 8058.698.030 | Rep. CX. F7000 a F8500 | | | 38 |
| CX.33050 | FORD | Rep. CX. F250 após 97 / F350 após 97 (Setor 35MM.) | | | 36 |
| CX.33055 | ZF. 8053.698.055 | Rep. CX. F1000 a F4000 até 89 | | | 38 |
| CX.33060 | ZF. 8058.698.031 | Rep. Sem Fim F7000 a F8500 | | | 38 |
| CX.33075 | FORD | Rep. CX. Ecosport / Fiesta / Amazon após 03 (Bucha + Êmbolo) | X | X | 38 |
| CX.33075/2 | FORD | Rep. CX. Ecosport / Fiesta / Amazon após 03 (Bucha + Êmbolo) | | X | 38 |
| CX.33095 | ZF. 7852.633.021 | Rep. CX. Ford (Importada) (Cód. Caixa 7852.991.123/124/130) | | | 38 |
| CX.33101 | ZF. 8053.698.013 | Rep. Sem Fim F1000 a F4000 / F19000 | | | 35 |
| CX.33102 | BENDIX | Rep. CX. Ford Cargo | | | 39 |
| CX.33103 | TRINTER | Rep. CX. Escort / Verona 92... | X | X | 39 |
| CX.33103/2 | TRINTER | Rep. CX. Escort / Verona 92... | | X | 39 |
| CX.33104 | FORD | Rep. CX. Fiesta / Courier 98... / Mondeo (92 a 02) / KA 96... | X | X | 39 |
| CX.33104/2 | FORD | Rep. CX. Fiesta / Courier 98... / Mondeo (92 a 02) / KA 96... | | X | 39 |
| CX.33119 | TRW | Rep. CX. Ford Focus 02... | X | X | 39 |
| CX.33119/2 | TRW | Rep. CX. Ford Focus 02... | | X | 39 |
| CX.33121 | TRINTER | Rep. CX. Escort 97... (Motor Zetec) | X | X | 39 |
| CX.33121/2 | TRINTER | Rep. CX. Escort 97... (Motor Zetec) | | X | 39 |
| CX.33151/2 | FORD | Rep. CX. Mustang (86 a 88) e (96 a 02) | | | 38 |
| CX.33163 | FORD-7E51-3200-A | Rep. CX. Fusion (06 a 09) K052X, (AE-78C6098) com coifas | X | | 45 |
| CX.33163/2 | FORD-7E51-3200-A | Rep. CX. Fusion (06 a 09) K052X, (AE-78C6098) sem coifas | | | 45 |
| CX.33164 | FOMOCO | Rep. CX. Focus 2011... TENDRIVE.GCYB > AL-SI9CU3 | X | X | 48 |
| CX.33164/2 | FOMOCO | Rep. CX. Focus 2011... TENDRIVE.GCYB > AL-SI9CU3 | | X | 48 |
| CX.33165 | FORD | Rep. CX. Taurus (86 a 95) e (90 a 92) Com e Sem Assistência Variável | X | | 38 |
| CX.33165/2 | FORD | Rep. CX. Taurus (86 a 95) e (90 a 92) Com e Sem Assistência Variável | | | 38 |
| CX.33200 | TRINTER | Rep. CX. Ford Focus Trinter 02... com coifas | X | X | 39 |

(+) Ford (+)

| Cód. AGEL | Ref. Mercado | Aplicação | Coifas | Buchas | Página |
|------------|------------------|---|--------|--------|--------|
| CX.33200/2 | TRINTER | Rep. CX. Ford Focus Trinter 02... | | X | 39 |
| CX.33206 | ZF. 7832.698.206 | Rep. CX. Del Rey / Belina / Pampa / Scala (84 a 96) com coifas | X | | 38 |
| CX.33206/2 | ZF. 7832.698.206 | Rep. CX. Del Rey / Belina / Pampa / Scala (84 a 96) sem coifas | | | 38 |
| CX.33210 | ZF. 8053.698.210 | Rep. CX. F1000 a F4000 | | | 35 |
| CX.33218 | ZF. 8053.698.218 | Rep. CX. F1000 | | | 38 |
| CX.33220/2 | FORD | Rep. CX. Ford Taurus (00 a 02) / Windstar (01 a 03) | | | 39 |
| CX.33221/2 | FORD | Rep. CX. Ford Windstar (95 a 97) | | | 39 |
| CX.33222 | VISTEON | Rep. CX. Ford Focus (00 a 05) com coifas | X | | 45 |
| CX.33222/2 | VISTEON | Rep. CX. Ford Focus (00 a 05) sem coifas | | | 45 |
| CX.33223 | FORD TRANSIT | Rep. CX. Ford Transit 08... com coifas | X | | 48 |
| CX.33223/2 | FORD TRANSIT | Rep. CX. Ford Transit 08... sem coifas | | | 48 |
| CX.33226 | ZF. 8097.698.226 | Rep. CX. Cargo 1717 a 5031 (Tampas de Plástico) | | | 37 |
| CX.33230 | ZF. 8095.698.230 | Rep. CX. Servocom F11000 a 14000 (Tampas laterais de plástico) | | | 38 |
| CX.33231 | ZF. 8095.298.808 | Rep. CX. Servocom F11000 a 14000 (Tampas laterais de borracha) | | | 38 |
| CX.33238 | ZF. 7881.698.238 | Rep. CX. Versailles / Royale 92.. | X | | 38 |
| CX.33238/2 | ZF. 7881.698.238 | Rep. CX. Versailles / Royale 92.. | | | 38 |
| CX.33318 | FORD CX. TRW | Rep. CX. Fiesta EcoSport / KA 2010... com coifas Cx. TRW | X | X | 49 |
| CX.33318/2 | FORD CX. TRW | Rep. CX. Fiesta EcoSport / KA 2010... sem coifas Cx. TRW | | X | 49 |
| CX.33750 | TRW. 16.150.750 | Rep. CX. Escort / Verona 93 a 96 | X | X | 39 |
| CX.33750/2 | TRW. 16.150.750 | Rep. CX. Escort / Verona 93 a 96 | | X | 39 |
| CX.33754 | TRW. 16.150.754 | Rep. CX. Versailles / Royale 92... | X | | 38 |
| CX.33754/2 | TRW. 16.150.754 | Rep. CX. Versailles / Royale 92... | | | 38 |
| CX.33764 | TRW. 22.150.764 | Rep. CX. F1000 a F4000 (92 a 98) / F250 / F350 após 97 (TAS-20) | | | 39 |
| CX.33771 | TRW. 16.150.771 | Rep. CX. Ford 814 (TAS-30) | | | 38 |
| CX.33775 | TRW. 22.150.775 | Rep. CX. Cargo 1215 a 1422 (TAS-65) com junta | | | 39 |
| CX.33775/3 | TRW. 22.150.775 | Rep. CX. Cargo 1215 a 1422 (TAS-65) sem junta | | | 39 |
| CX.33810 | ZF. 8097.298.810 | Rep. CX. Cargo 1717 a 5031 (Tampas de Borracha) | | | 38 |
| CX.33907 | ZF | Rep. CX. Escort após 92 com coifas | X | X | 48 |

(+) Ford

| Cód. AGEL | Ref. Mercado | Aplicação | Coifas | Buchas | Página |
|------------|--------------|--|--------|--------|--------|
| CX.33907/2 | ZF | Rep. CX. Escort após 92 sem coifas | | X | 48 |
| CX.33914 | FORD | Rep. CX. Ranger 98 a 03... / Explorer 95 (Conexão rosca) | X | X | 39 |
| CX.33914/2 | FORD | Rep. CX. Ranger 98 a 03... / Explorer 95 (Conexão rosca) | | X | 39 |
| CX.33915 | FORD | Rep. CX. Ranger após 01 (Conexão engate rápido) | X | X | 45 |
| CX.33915/2 | FORD | Rep. CX. Ranger após 01 (Conexão engate rápido) | | X | 45 |
| CX.33916 | FORD VISTEON | Rep. Cx. Ranger Pinhão e Cremalheira (Com Rosca / Plug Com Coifas) | X | X | 48 |
| CX.33916/2 | FORD VISTEON | Rep. Cx. Ranger Pinhão e Cremalheira (Com Rosca / Plug) | | X | 48 |
| CX.33917 | FORD | Rep. Cx. FOMOCO - Ranger 2013... com coifas | X | | 49 |
| CX.33917/2 | FORD | Rep. Cx. FOMOCO - Ranger 2013... | | | 49 |
| CX.33924 | FORD | Rep. CX. Ranger (94 a 97) / Explorer (91 a 94) (Setor 33MM.) | | | 39 |

(+) Honda

| Cód. AGEL | Ref. Mercado | Aplicação | Coifas | Buchas | Página |
|------------|--------------|--|--------|--------|--------|
| CX.33852/2 | KOYO | Rep. CX. Honda Accord (98 a 03) 04Cil. | | | 49 |
| CX.33853/2 | KOYO | Rep. CX. Honda Accord (94 a 97) 04 Cil. | | | 49 |
| CX.33854/2 | KOYO | Rep. CX. Honda Accord (98 a 02) 06 Cil. | | | 49 |
| CX.33855/2 | SHOWA | Rep. CX. Honda CR-V 07... | | | 49 |
| CX.33856 | TRW | Rep. CX. Honda Civic (96 a 99) (Bucha Longa 54MM) | X | X | 49 |
| CX.33856/2 | TRW | Rep. CX. Honda Civic (96 a 99) (Bucha Longa 54MM) | | X | 49 |
| CX.33857 | TRW | Rep. CX. Accord 4 Cil. 06 a 07 / CRV 98 a 01 / New Civic após 06... com coifas | X | | 49 |
| CX.33857/2 | TRW | Rep. CX. Accord 4 Cil. 06 a 07 / CRV 98 a 01 / New Civic após 06... | | | 49 |

Honda (+)

| Cód. AGEL | Ref. Mercado | Aplicação | Coifas | Buchas | Página |
|------------|---------------|---|--------|--------|--------|
| CX.22057 | BBA Importada | Rep. BBA. New Civic 2006... (Legacy) | | | 49 |
| CX.22058 | BBA Importada | Rep. BBA. Civic / CRV- Accord 4cc 01 A 02 (Legacy) | | | 49 |
| CX.22080 | KOYO | Rep. BBA. Honda Civic (96 a 00) / Accord(98 a 02) Exceto V6 Odyssey 98 | | | 33 |
| CX.33834/2 | KOYO | Rep. CX. Honda Civic (96 a 00) | | | 49 |
| CX.33835/2 | SHOWA | Rep. CX. Honda Civic (01 a 06) | | | 49 |
| CX.33849 | SHOWA | Rep. CX. Honda Civic (92 a 95) (Com Gaxetas) Rep. CX. Honda Del Sol (93 a 95) Exceto V-Tec (Com Gaxetas) | X | | 36 |
| CX.33849/2 | SHOWA | Rep. CX. Honda Civic (92 a 95) (Com Gaxetas) Rep. CX. Honda Del Sol (93 a 95) Exceto V-Tec (Com Gaxetas) | | | 36 |
| CX.33850 | TRW | Rep. CX. Honda Civic (96 a 99) (Bucha Curta 42MM.) | X | X | 39 |
| CX.33850/2 | TRW | Rep. CX. Honda Civic (96 a 99) (Bucha Curta 42MM.) | | X | 39 |
| CX.33851 | SHOWA | Rep. CX. Honda New Civic após 06 (Exceto SI) com coifa | X | X | 49 |
| CX.33851/2 | SHOWA | Rep. CX. Honda New Civic após 06 (Exceto SI) | | X | 49 |

Hyundai (+)

| Cód. AGEL | Ref. Mercado | Aplicação | Coifas | Buchas | Página |
|------------|------------------|---|--------|--------|--------|
| CX.22055 | Importado | Rep. BBA. Azera 2010... (importado) | | | 49 |
| CX.22056 | Importado | Rep. BBA. Santa Fé 2011... (importado) | | | 49 |
| CX.22300 | YOUNG SHIN | Rep. BBA. Hyundai HR após 07 | | | 39 |
| CX.22940 | KOYO | Rep. BBA. Hyundai Tucson após 05 | | | 50 |
| CX.33500/2 | KOYO | Rep. CX. Hyundai H1 | | | 50 |
| CX.33501/2 | KOYO | Rep. CX. Hyundai Trajet | | | 50 |
| CX.33502 | MANDO 577002B000 | Rep. CX. Santa Fé 01 a 06 | | | 50 |
| CX.33502/2 | MANDO 577002B000 | Rep. CX. Hyundai Santa Fé 01 a 06 | | | 50 |
| CX.33503 | MANDO 577002B210 | Rep. CX. Hyundai Santa Fé após 07... c/ coifa | X | X | 45 |
| CX.33503/2 | MANDO 577002B210 | Rep. CX. Hyundai Santa Fé após 07... s/ coifa | | X | 45 |
| CX.33504 | MANDO | Rep. CX. Hyundai HR após 07 | X | X | 45 |
| CX.33504/2 | MANDO | Rep. CX. Hyundai HR após 07 | | X | 45 |
| CX.33506/2 | KOYO | Rep. CX. Hyundai Elantra (96 a 00) | | | 50 |
| CX.33507/2 | KOYO / TRW | Rep. CX. Hyundai H100 | | | 50 |
| CX.33508/2 | KOYO | Rep. CX. Hyundai Excel (86 a 96) | | | 50 |

(+) Hyundai

| Cód. AGEL | Ref. Mercado | Aplicação | Coifas | Buchas | Página |
|------------|--------------|---|--------|--------|--------|
| CX.33510/2 | MANDO | Rep. CX. Hyundai H100 | | | 50 |
| CX.33511/2 | MANDO | Rep. CX. Hyundai Azera após 08... | | | 50 |
| CX.33512 | MANDO | Rep. CX. Hyundai Tucson após 06... com coifas KNC. 577001f800 | X | X | 45 |
| CX.33512/2 | MANDO | Rep. CX. Hyundai Tucson após 06... | | X | 45 |
| CX.33513 | MANDO | Rep. CX. Mando Hyundai IX 35 2013... com coifas | X | X | 50 |
| CX.33513/2 | MANDO | Rep. CX. Mando Hyundai IX 35 2013... sem coifas | | X | 50 |

Jeep

| Cód. AGEL | Ref. Mercado | Aplicação | Coifas | Buchas | Página |
|-----------|---------------|--|--------|--------|--------|
| CX.22003 | BOMBA TC 17MM | Rep. BBA. Jeep Grand Cherokee (96 a 98) / Wrangler (97 a 99) Rep. BBA. Jeep Cherokee / Comanche / Wagoneer (96 a 98) | | | 33 |
| CX.22107 | SAGINAW | Rep. BBA. Cherokee / Comanche / Wrangler (Reservatório acoplado) | | | 34 |
| CX.33089 | SAGINAW | Rep. CX. Jeep Cherokee / Comanche / Wagoneer (93 a 95) Rep. CX. Jeep Grand Cherokee (93 a 95) / Jeep Wrangler (93 a 96) | | | 35 |
| CX.33090 | DHB / SAGINAW | Rep. CX. Jeep Grand Cherokee (96 a 98) / Jeep Wrangler (97 a 01) | | | 36 |
| CX.33146 | TRW | Rep. CX. Jeep Cherokee / Jeep Chrysler / Jeep Wrangler | | | 40 |

Iveco

| Cód. AGEL | Ref. Mercado | Aplicação | Coifas | Buchas | Página |
|------------|------------------|--|--------|--------|--------|
| CX.22001 | ZF. 7683.698.001 | Rep. BBA. Iveco Turbo Daily / 150 e 20 N/T e 160 e 23 N/T FN4 | | | 46 |
| CX.22020 | ZF. 8695.955.116 | Rep. BBA. Iveco Eurocargo / Stralis (Cód. BBA. 8695.955.116) | | | 50 |
| CX.33230 | ZF. 8095.698.230 | Rep. CX. Iveco Eurocargo (Tampas laterais de plástico) | | | 38 |
| CX.33231 | ZF. 8095.298.808 | Rep. CX. Iveco Eurocargo (Tampas laterais de borracha) | | | 38 |
| CX.33810 | ZF. 8097.298.810 | Rep. CX. Iveco Eurotrakker / Eurocargo (Tampas laterais de borracha) Rep. CX. Iveco Stralis / 140 / 190 (Tampas laterais de borracha) | | | 38 |
| CX.33811 | ZF. 8098.298.800 | Rep. CX. Iveco Expression / CC170 E22 Iribus | | | 40 |
| CX.33940 | TRW | Rep. CX. Iveco Turbo Daily | X | X | 37 |
| CX.33940/2 | TRW | Rep. CX. Iveco Turbo Daily | | X | 37 |
| CX.33943 | TRW | Rep. CX. Iveco Turbo Daily 55C16-2010... (Caixa Blindada) | X | | 43 |
| CX.33943/2 | TRW | Rep. CX. Iveco Turbo Daily 55C16-2010... (Caixa Blindada) | | | 43 |

Kia

| Cód. AGEL | Ref. Mercado | Aplicação | Coifas | Buchas | Página |
|------------|--------------|--|--------|--------|--------|
| CX.22300 | KIO | Rep. BBA. Grand Besta (Ret. 20MM.) | | | 39 |
| CX.22940 | KOYO | Rep. BBA. Kia Sportage 05... | | | 50 |
| CX.33072 | TRW | Rep. CX. Kia Carnival...07 | X | | 40 |
| CX.33072/2 | TRW | Rep. CX. Kia Carnival...07 | | | 40 |
| CX.33116 | TRW | Rep. CX. Kia Besta / Bongo K-2700 | X | | 46 |
| CX.33116/2 | TRW | Rep. CX. Kia Besta / Bongo K-2700 | | | 46 |
| CX.33512 | MANDO | Rep. CX. Kia Sportage (05 a 06) com coifas | X | X | 45 |
| CX.33512/2 | MANDO | Rep. CX. Kia Sportage (05 a 06) | | X | 45 |
| CX.33938 | KIA | Rep. CX. Kia Sportage (05 a 06) | | | 40 |

Land Rover

| Cód. AGEL | Ref. Mercado | Aplicação | Coifas | Buchas | Página |
|-----------|------------------|---|--------|--------|--------|
| CX.22051 | KYB / ZF | Rep. BBA. Land Rover/Range Rover 4.6 Gas. Após 99 (Eixo 15MM) | | | 47 |
| CX.33901 | INGLATERRA | Rep. CX. Land Rover Defender (04 Fixações) após 93 | | | 50 |
| CX.33902 | INGLATERRA | Rep. CX. Land Rover Defender / Range Rover (03 Fixações) após 93 | | | 50 |
| CX.33903 | INGLATERRA | Rep. CX. Land Rover Defender (04 + 02 Fixações) após 93 | | | 50 |
| CX.33904 | INGLATERRA | Rep. CX. Land Rover / Range Rover (91 a 02) Série I (STC2847) Rep. CX. Range Rover (91 a 02) Série I (STC2847) | | | 45 |
| CX.33905 | ZF. 8055.633.022 | Rep. CX. Range Rover | | | 40 |

Lexus

| Cód. AGEL | Ref. Mercado | Aplicação | Coifas | Buchas | Página |
|------------|--------------|---------------------------------|--------|--------|--------|
| CX.33241 | KOYO | Rep. CX. Lexus ES300 com coifas | X | | 50 |
| CX.33241/2 | KOYO | Rep. CX. Lexus ES300 | | | 50 |

Mazda

| Cód. AGEL | Ref. Mercado | Aplicação | Coifas | Buchas | Página |
|------------|--------------|--|--------|--------|--------|
| CX.22100 | FORD | Rep. BBA. Mazda B2300 (94 a 97) / B2500 (98 a 99) / Protégé 01 Rep. BBA. Mazda B3000 / B4000 (94 a 99) / Navajo (91 a 95) | | | 37 |
| CX.33182/2 | TRW | Rep. CX. Mazda MPV Van 4 x 2 / 4 x 4 (89 a 95) | | | 40 |
| CX.33183 | TRW | Rep. CX. Mazda 626 (93 a 99) / MX-6 (93 a 97) | X | | 40 |
| CX.33183/2 | TRW | Rep. CX. Mazda 626 (93 a 99) / MX-6 (93 a 97) | | | 40 |
| CX.33924 | FORD | Rep. CX. Mazda Navajo (91 a 94) (Setor 33MM.) | | | 39 |

Mercedes (+)

| Cód. AGEL | Ref. Mercado | Aplicação | Coifas | Buchas | Página |
|-----------|------------------|---|--------|--------|--------|
| CX.22001 | ZF. 7683.698.001 | Rep. BBA. 1938S / OM449LA / OM447LA / O-400 (Motor BR-400) FN4 Rep. BBA. SLK (Motor BR-450) / Ônibus O-400 (Motor BR-450) FN4 Rep. BBA. L98 (Motor BR-900) / LS 1632 ano 98 / 2325 ano 99 FN4 | | | 46 |
| CX.22002 | ZF. 7683.698.002 | Rep. BBA. 1620 / 1623 / 1720 FN3 | | | 40 |
| CX.22005 | ZF. 7681.698.258 | Rep. BBA. MB 180 | | | 46 |
| CX.22022 | ZF. 7673.698.022 | Rep. BBA. (ZF 125) - 1113 a 2213 | | | 33 |
| CX.22023 | ZF. 7673.698.023 | Rep. BBA. (ZF 908) - 1519 / 1520 - 1924 a 1934 | | | 33 |
| CX.22030 | ZF. 7673.698.030 | Rep. BBA. FPN / HPN Ônibus OF 1618 / 1620 | | | 40 |
| CX.22090 | LUK | Rep. BBA. Sprinter (Bomba acoplada com bomba vácuo) | | | 34 |
| CX.22105 | BOSCH | Rep. BBA. Bosch Ref. 25 x 40 x 08 | | | 40 |
| CX.22167 | MBB. 000466167 | Rep. Reservatório (Só Borracha) | | | 40 |
| CX.22208 | ZF. 7673.955.545 | Rep. BBA. Mercedes (1418) Novo | | | 44 |
| CX.22249 | ZF. 7691.698.249 | Rep. BBA. Sprinter | | | 34 |
| CX.22263 | ZF. 7673.698.263 | Rep. BBA. 1214 / 1218 / 1414 - 1418 / 1714 / 2418 | | | 40 |
| CX.22811 | ZF. 7673.298.801 | Rep. BBA. Mercedes 1618 / 1935 (Cód. BBA. 7673.955.534/545/711) | | | 40 |
| CX.33002 | ZF. 8065.698.002 | Rep. CX. 1924 / 1929 / 1932 / 1933 / 1934 | | | 41 |
| CX.33005 | TRW. 22.150.404 | Rep. Árvore de Entrada (HFB 64) Ônibus OF/OH 1115 / 1315 / 1318 | | | 40 |
| CX.33007 | ZF. 8062.698.007 | Rep. CX. 1113 a 2213 (Antiga) | | | 41 |
| CX.33017 | ZF. 8065.698.017 | Rep. CX. 1935 a 1941 - 0370 - 0371 | | | 37 |
| CX.33030 | ZF. 8058.698.030 | Rep. CX. 709 / 912 / 809 / 812 / 914 | | | 38 |
| CX.33052 | DAIMER CHRYSLER | Rep. CX. Mercedes 1620 (LS6 BK) | | | 51 |
| CX.33053 | DAIMER CHRYSLER | Rep. CX. Mercedes 1933 Axor (LS8 BK) | | | 51 |
| CX.33060 | ZF. 8058.698.031 | Rep. Sem Fim 709 / 912 / 809 / 812 / 914 | | | 38 |
| CX.33061 | ZF. 8063.698.173 | Rep. Sem Fim (8062 / 8063) | | | 41 |
| CX.33080 | ZF | Rep. CX. Mercedes 200 / 230 / 250 / 280 / 300 / 320 / 350 Rep. CX. Mercedes Classe C - C250 / C280 até 97 (Pistão 68 mm.) | | | 41 |

(+) Mercedes

| Cód. AGEL | Ref. Mercado | Aplicação | Coifas | Buchas | Página |
|------------|---------------------|---|--------|--------|--------|
| CX.33081 | ZF | Rep. CX. Mercedes 200 / 220 / 230 / 240 / 250 / 280 (Pistão 86MM) | | | 41 |
| CX.33082/2 | ZF | Rep. CX. Mercedes Classe M após 97... | | | 41 |
| CX.33083/2 | ZF | Rep. CX. Mercedes Classe E | | | 41 |
| CX.33084/2 | ZF | Rep. CX. Mercedes ML320 / ML430 (98 a 01) | | | 51 |
| CX.33170 | ZF. 8063.698.170 | Rep. CX. 1113 a 2218 (Moderna) | | | 41 |
| CX.33180 | TRW | Rep. CX. MB 180 (TAS-15) | | | 41 |
| CX.33226 | ZF. 8097.698.226 | Rep. CX. Servocom - 1614 a 1620 (Tampas de plástico) | | | 37 |
| CX.33230 | ZF. 8095.698.230 | Rep. CX. Servocom - 1218 a 2214 (Tampas laterais de plástico) | | | 38 |
| CX.33231 | ZF. 8095.298.808 | Rep. CX. Servocom - 1218 a 2214 (Tampas laterais de borracha) | | | 38 |
| CX.33255 | ZF. 8090.698.255 | Rep. CX. L0914 / L709 / L912 / L98 / 712C / 914C | | | 46 |
| CX.33261 | ZF. 8063.698.261 | Rep. CX. Ônibus 370/12 | | | 41 |
| CX.33610 | MBB. 9014610401 | Rep. CX. Sprinter (97 a 07) Sem Fim Fino | X | X | 41 |
| CX.33610/2 | MBB. 9014610401 | Rep. CX. Sprinter (97 a 07) Sem Fim Fino | | X | 41 |
| CX.33611 | MBB. 9014611401 | Rep. CX. Sprinter (97 a 07) Sem Fim Grosso | X | X | 41 |
| CX.33611/2 | MBB. 9014611401 | Rep. CX. Sprinter (97 a 07) Sem Fim Grosso | | X | 41 |
| CX.33612 | MBB | Rep. CX. Sprinter (97 a 07) Sem Fim Fino/Grosso | X | X | 41 |
| CX.33612/2 | MBB | Rep. CX. Sprinter (97 a 07) Sem Fim Fino/Grosso | | X | 41 |
| CX.33800 | ZF. 8065.298.800 | Rep. CX. 1935 / 2635 / 1938 / 1941 (Troleibus) | | | 41 |
| CX.33810 | ZF. 8097.298.810 | Rep. CX. Servocom (Todos 8097) (Tampas de borracha) | | | 38 |
| CX.33811 | ZF. 8098.298.800 | Rep. CX. Servocom - OF 1732 / 2836GL / GLE / 0-500 M/R/U Rep. CX. Servocom - Axor 1933S a 2828S Rep. CX. Servocom 3340K / 3340S / 3344K / 3344S | | | 40 |
| CX.33865 | TRW | Rep. CX. Mercedes Classe A (98 a 05) com coifas | X | X | 51 |
| CX.33865/2 | TRW | Rep. CX. Mercedes Classe A (98 a 05) | | X | 51 |
| CX.33900 | TRW. 22.150.783/787 | Rep. CX. Ônibus / Caminhão OF/OH 1115 / 1315 / 1318 (HFB 64) i5990 | | | 41 |

Mitsubishi

| Cód. AGEL | Ref. Mercado | Aplicação | Coifas | Buchas | Página |
|------------|--------------|--|--------|--------|--------|
| CX.22009 | KOYO | Rep. BBA. Mitsubishi 3000 GT (90 a 94) / Mirage (93 a 94) | | | 51 |
| CX.22010 | KOYO | Rep. BBA. Mitsubishi 3000 GT (95 a 98) / Diamante (95 a 02) Rep. BBA. Mitsubishi Galant (90 a 92) / Mirage (96 a 98) Rep. BBA. Mitsubishi Pajero (92 a 98) / Eclipse (91 a 93) | | | 42 |
| CX.22300 | KIO | Rep. BBA. Mitsubishi L200 após 95 (Ret. 20MM) | | | 39 |
| CX.22931 | KOYO | Rep. BBA. Mitsubishi L200 / L300 após 94 | | | 42 |
| CX.22933 | KOYO | Rep. BBA. Mitsubishi Eclipse (94 a 99) | | | 51 |
| CX.33128/2 | TRW | Rep. CX. Outlander Airtrek 03/05 sem Coifas | | | 51 |
| CX.33160/2 | KOYO | Rep. CX. Mitsubishi Space Wagon / Cordia / Tredia (84 a 87) | | | 42 |
| CX.33921 | KOYO | Rep. CX. L200 (92 a 03) (Setor 30MM.) | | | 51 |
| CX.33930/2 | KOYO | Rep. CX. Mitsubishi Space Wagon / Expo (92 a 97) | | | 51 |
| CX.33931 | KOYO | Rep. CX. Mitsubishi L200 (92 a 03) (Setor 32MM) | | | 42 |
| CX.33933 | KOYO | Rep. CX. Mitsubishi L200 Sport / L200 GLS após 03 (Setor 35MM) | | | 42 |
| CX.33934 | KOYO | Rep. CX. Mitsubishi Pajero Full após 02... com coifas | X | X | 51 |
| CX.33934/2 | KOYO | Rep. CX. Mitsubishi Pajero Full após 02... | | X | 51 |
| CX.33935 | MANDO | Rep. CX. Mitsubishi Pajero / Pajero Sport (94 a 01) / Montero | | | 40 |
| CX.33936/2 | MANDO | Rep. CX. Mitsubishi L300(Ret.Cremalheira 27,7x46x13 + 27,7x42x12,50) | | | 51 |
| CX.33937 | KOYO | Rep. CX. Mitsubishi L200 Triton 08... com coifas (Cremalheira 32MM) | X | | 51 |
| CX.33937/2 | KOYO | Rep. CX. Mitsubishi L200 Triton 08... (Cremalheira 32MM) | | | 51 |
| CX.33939/2 | KOYO / TRW | Rep. CX. Mitsubishi Eclipse (95 a 99) / Galant (93 a 96) | | | 51 |
| CX.33941/2 | KOYO | Rep. CX. Mitsubishi Eclipse (05 a 06) / Galant (03 a 04) | | | 51 |
| CX.33942/2 | KOYO | Rep. CX. Mitsubishi Pajero TR4 após 02 / 10 (99 a 02) | | X | 51 |
| CX.33944 | KOYO | Rep. CX. Koyo S/Fim - Mitsubishi L-200 92 a 03 Setor 30 e 32MM | | | 52 |

Nissan

| Cód. AGEL | Ref. Mercado | Aplicação | Coifas | Buchas | Página |
|------------|--------------|--|--------|--------|--------|
| CX.22090 | LUK | Rep. BBA. Frontier após 01 (Bomba acoplada com bomba vácuo) | | | 34 |
| CX.33246/2 | KOYO | Rep. CX. Nissan Frontier após 05... (Retentor 32x53) | | | 32 |
| CX.33926/2 | TRW | Rep. CX. Nissan Saloon Ex / Super após 93 Rep. CX. Nissan Sentra 99 a 06 / 200 SX 95 a 98 | | | 42 |
| CX.33929 | DELPHI | Rep. CX. Nissan Frontier 02... / X-Terra 04... | | | 42 |
| CX.33945 | KOYO | Rep. CX. Frontier 2010... N° 8124025/ S. CO LTD com coifas | X | | 52 |
| CX.33945/2 | KOYO | Rep. CX. Frontier 2010... N° 8124025/ S. CO LTD | | | 52 |
| CX.33967/2 | KOYO | Rep. CX. Nissan Pathfinder (95 a 04) V6 - 3.5L | | | 52 |
| CX.33968 | KOYO | Rep. CX. Nissan Pathfinder ... 95 / X-Terra 01... | | | 42 |

Peugeot (+)

| Cód. AGEL | Ref. Mercado | Aplicação | Coifas | Buchas | Página |
|------------|------------------|---|--------|--------|--------|
| CX.22001 | ZF. 7683.698.001 | Rep. BBA. Peugeot Boxer | | | 46 |
| CX.22304 | DHB. 1.804.304 | Rep. BBA. Peugeot 206 após 02 / 307 após 01 / 405 SRI (92 a 98) | | | 34 |
| CX.22936 | KOYO | Rep. BBA. Peugeot 206 - 1.0 e 1.6 / 307 após 01 (Com Junta) | | | 52 |
| CX.33115 | TRW | Rep. CX. Peugeot 206 / 307 (Válvula TRW + Carcaça T1 ou T5) | X | X | 42 |
| CX.33115/2 | TRW | Rep. CX. Peugeot 206 / 307 (Válvula TRW + Carcaça T1 ou T5) | | X | 42 |
| CX.33120 | ZF | Rep. Válvula Peugeot 405 / 605 | X | | 42 |
| CX.33150 | TRW | Rep. Válvula Peugeot 106 / 306 após 96 | X | | 36 |
| CX.33153 | ZF | Rep. Válvula Peugeot Partner (Ret. Inf. Ext. 43 e 47MM) | X | | 36 |
| CX.33156 | TRW | Rep. CX. Peugeot 806 / Expert (94 a 02) | X | | 36 |
| CX.33156/2 | TRW | Rep. CX. Peugeot 806 / Expert (94 a 02) | | | 36 |
| CX.33172 | ZF | Rep. CX. Peugeot 206 / 307 / (Válvula ZF + Carcaça T5) | X | X | 42 |
| CX.33172/2 | ZF | Rep. CX. Peugeot 206 / 307 / (Válvula ZF + Carcaça T5) | | X | 42 |
| CX.33173 | REP. CX.206MIX | Rep. CX. Peugeot 206 MIX com coifas | X | X | 45 |
| CX.33173/2 | REP. CX.206MIX | Rep. CX. Peugeot 206 MIX sem coifas | | X | 45 |

(+) Peugeot

| Cód. AGEL | Ref. Mercado | Aplicação | Coifas | Buchas | Página |
|------------|--------------|-----------------------------------|--------|--------|--------|
| CX.33175/2 | ZF | Rep. CX. Peugeot 406 (Carcaça D9) | | | 42 |
| CX.33940 | TRW | Rep. CX. Peugeot Boxer (94 a 02) | X | X | 37 |
| CX.33940/2 | TRW | Rep. CX. Peugeot Boxer (94 a 02) | | X | 37 |

Renault (+)

| Cód. AGEL | Ref. Mercado | Aplicação | Coifas | Buchas | Página |
|------------|-----------------------|--|--------|--------|--------|
| CX.22001 | ZF. 7683.698.001 | Rep. BBA. Renault Master | | | 46 |
| CX.22107 | SAGINAW | Rep. BBA. Renault Megane (Reservatório Acoplado) | | | 34 |
| CX.22304 | DHB. 1.804.304 | Rep. BBA. Clio / Kangoo / Megane / Scenic após 2002 | | | 34 |
| CX.22802 | ZF. 7683.298.802 | Rep. BBA. Renault Master (Cód. BBA. 7683.955.114/911/926) | | | 36 |
| CX.22936 | IMPORTADA | Rep. BBA. Clio - 1.0 e 1.6 (Com Junta) | | | 52 |
| CX.33112 | KOYO / BENDIX | Rep. CX. Renault Trafic (Retentores com abas) | X | | 35 |
| CX.33112/2 | KOYO / BENDIX | Rep. CX. Renault Trafic (Retentores com abas) | | | 35 |
| CX.33117 | KOYO - 7740000015 | Rep. CX. Renault Scenic / Megane após 98... | X | X | 42 |
| CX.33117/2 | KOYO - 7740000015 | Rep. CX. Renault Scenic / Megane após 98... | | X | 42 |
| CX.33118 | KOYO - 771/7720000004 | Rep. CX. Renault Clio 1.0 e 1.6 / Kangoo após 99 / Symbol após 10... | X | | 42 |
| CX.33118/2 | KOYO - 771/7720000004 | Rep. CX. Renault Clio 1.0 e 1.6 / Kangoo após 99 / Symbol após 10... | | | 42 |
| CX.33123 | KOYO | Rep. CX. Renault Symbol 2010... | X | | 52 |
| CX.33123/2 | KOYO | Rep. CX. Renault Symbol 2010... | | | 52 |
| CX.33124 | JTEKT | Rep. CX. Renault Sandero / Logan 2013... | X | X | 52 |
| CX.33124/2 | JTEKT | Rep. CX. Renault Sandero / Logan 2013... | | X | 52 |
| CX.33125 | SMI / RENAULT | Rep. CX. Renault Clio 94 a 98 / 19 (93 a 99) (Cremalheira 25MM) | X | | 42 |
| CX.33125/2 | SMI / RENAULT | Rep. CX. Renault Clio 94 a 98 / 19 (93 a 99) (Cremalheira 25MM) | | | 42 |
| CX.33126 | ZF | Rep. CX. Renault 19 / Renault 21 / Nevada (93 a 99) | X | | 43 |
| CX.33126/2 | ZF | Rep. CX. Renault 19 / Renault 21 / Nevada (93 a 99) | | | 43 |
| CX.33137 | TRW | Rep. CX. Renault Scenic / Megane até 99 | X | X | 43 |

(+) Renault

| Cód. AGEL | Ref. Mercado | Aplicação | Coifas | Buchas | Página |
|------------|--------------|---|--------|--------|--------|
| CX.33137/2 | TRW | Rep. CX. Renault Scenic / Megane até 99 | | X | 43 |
| CX.33140 | KOYO/SMI | Rep. CX. Trafic (Retentores sem abas) | X | | 43 |
| CX.33140/2 | KOYO/SMI | Rep. CX. Trafic (Retentores com abas) | | | 43 |
| CX.33141 | UNIVERSAL | Rep. CX. Universal Trafic com coifas | X | | 52 |
| CX.33141/2 | UNIVERSAL | Rep. CX. Universal Trafic sem coifas | | | 52 |
| CX.33142/2 | MASTER KOYO | Rep. CX. Renault Master (03 a 08) (Ret. Carcaça Ext. 45 e 46MM) | | X | 45 |
| CX.33144/2 | MASTER JEKT | Rep. CX. JETKT KOYO após 10... | | | 45 |
| CX.33176 | KOYO | Rep. CX. Laguna | X | | 52 |
| CX.33176/2 | KOYO | Rep. CX. Laguna | | | 52 |
| CX.33279/2 | TRW | Rep. CX. Duster após 13... | | X | 45 |
| CX.33846 | TRW | Rep. CX. Logan / Sandero após 07... | X | X | 52 |
| CX.33846/2 | TRW | Rep. CX. Logan / Sandero após 07... | | X | 52 |

Scania (+)

| Cód. AGEL | Ref. Mercado | Aplicação | Coifas | Buchas | Página |
|-----------|---------------------|---|--------|--------|--------|
| CX.22001 | ZF. 7683.698.001 | Rep. BBA. P / R / T 94 / 114 / 124 FN4 | | | 46 |
| CX.22034 | ZF. 7677.698.034 | Rep. BBA. LT111 / T112 - B - L - LS | | | 43 |
| CX.22035 | ZF. 7677.698.035 | Rep. BBA. R124 - 143 - LK140 - 141 | | | 43 |
| CX.22104 | LUK-543.0035.10 | Rep. BBA. LUK 112 / 113 / 114 / 124 | | | 43 |
| CX.22801 | ZF. 7683.298.801 | Rep. BBA. Scania (Motor Cummins) | | | 37 |
| CX.33002 | ZF. 8065.698.002 | Rep. CX. BR110 / 115 - 116 | | | 41 |
| CX.33017 | ZF. 8065.698.017 | Rep. CX. BR111 | | | 37 |
| CX.33067 | ZF. 8044.955.119 | Rep. CX. 112 Sueca (Cód. Caixa 8044.955.119) | | | 52 |
| CX.33068 | ZF. 8044.698.068 | Rep. CX. R-K-T 112/113 - 142/143 | | | 43 |
| CX.33226 | ZF. 8097.698.226 | Rep. CX. Servocom R113 / L113 / S113 / Ônibus (Tampas de Plástico) | | | 37 |
| CX.33779 | TRW. 22.150.779/837 | Rep. CX. R-T-K113 / 124 / 143 (TAS-85301) / 114 / 124 (TAS85303/304) c/ junta | | | 43 |

(+) Scania

| Cód. AGEL | Ref. Mercado | Aplicação | Coifas | Buchas | Página |
|------------|---------------------|--|--------|--------|--------|
| CX.33779/3 | TRW. 22.150.779/837 | Rep. CX. R-T-K113 / 124 / 143 (TAS-85301) / 114 / 124 (TAS 85303/304) s/ junta | | | 43 |
| CX.33791 | TRW. 22.150.791 | Rep. CX. R-T 112 a 143 / K112 / 112TL (HFB-70) com junta | | | 43 |
| CX.33791/3 | TRW. 22.150.791 | Rep. CX. R-T 112 a 143 / K112 / 112TL (HFB-70) sem junta | | | 43 |
| CX.33810 | ZF. 8097.298.810 | Rep. CX. Servocom R113 / L113 / S113 / Ônibus (Tampas de Plástico) | | | 38 |
| CX.33811 | ZF. 8098.298.800 | Rep. CX. Scania Ônibus Exportação (8098) | | | 40 |

Subaru

| Cód. AGEL | Ref. Mercado | Aplicação | Coifas | Buchas | Página |
|------------|--------------|---|--------|--------|--------|
| CX.33044 | TRW | Rep. CX. Subaru Legacy (00 a 03) (Cremalheira 25MM) | X | X | 43 |
| CX.33044/2 | TRW | Rep. CX. Subaru Legacy (00 a 03) (Cremalheira 25MM) | | X | 43 |
| CX.33045/2 | KOYO | Rep. CX. Subaru Legacy (90 a 98) (2 Retentores Cremalheira 24x38,5MM) | | | 52 |
| CX.33046/2 | KOYO | Rep. CX. Subaru Legacy (00 a 01) / Impreza após 93 (Retentor Cremalheira 24x35 + 24x38,5MM) | | | 52 |
| CX.33047/2 | KOYO | Rep. CX. Subaru Legacy (05 a 07) (2 Retentores Cremalheira 24x42MM) | | | 52 |
| CX.33048/2 | KOYO | Rep. CX. Subaru Impreza (04 a 06) (Retentor Cremalheira 24x41 + 24x36,5 MM) | | | 52 |
| CX.33059/2 | KOYO | Rep. CX. Subaru Forester (05 a 07) (Cremalheira 23MM) | | | 52 |

Suzuki

| Cód. AGEL | Ref. Mercado | Aplicação | Coifas | Buchas | Página |
|------------|--------------|---|--------|--------|--------|
| CX.22012 | KOYO | Rep. BBA. Suzuki Swift (95 a 97) | | | 53 |
| CX.22930 | KOYO | Rep. BBA. Suzuki Vitara (96 a 98) | | | 54 |
| CX.22941 | KOYO | Rep. BBA. Suzuki Vitara (89 a 95) | | | 32 |
| CX.33320/2 | KOYO | Rep. CX. Gran Vitara 98 a 03 / Tracker GM 2008... Cremalheira | | | 54 |
| CX.33932 | KOYO SAMURAI | Rep. CX. Suzuki Sidekick (96 a 98) 1.6 / Vitara (Setor 28MM) até 97 | | | 43 |

Toyota

| Cód. AGEL | Ref. Mercado | Aplicação | Coifas | Buchas | Página |
|------------|-------------------|---|--------|--------|--------|
| CX.22011 | KOYO | Rep. BBA. Hilux (91 a 04) (Bomba com Polia) | | | 53 |
| CX.22600 | IMPORTADO | Rep. BBA. Toyota Bandeirantes (Motor Importado) | | | 43 |
| CX.22601 | KOYO | Rep. BBA. Hilux após 05 (Bomba de Engrenagem - Ferro) | | | 53 |
| CX.22603 | REP. IMPOR. ALUMI | Rep. BBA. Hilux Alumi com Engrenagem Pit Bull | | | 53 |
| CX.22933 | KOYO | Rep. BBA. Toyota Hilux Gasolina (96 a 99) / Landcruiser 98 a 02 / Camry | | | 51 |
| CX.22934 | KOYO | Rep. BBA. Toyota Previa (90 a 97) | | | 53 |
| CX.22936 | KOYO | Rep. BBA. Toyota Corolla (97 a 02) / Paseo (96 a 97) (Com junta) | | | 52 |
| CX.22938 | KOYO | Rep. BBA. Toyota RAV4 (96 a 00) / Celica (94 a 95) / Hilux Gasolina | | | 53 |
| CX.33113 | TOYOTA | Rep. CX. Toyota Hilux SW4 / SR5 / SRV (91 a 95) (Setor 36MM) | | | 43 |
| CX.33114 | TOYOTA | Rep. CX. Toyota Hilux SW4 (96 a 04) (Cremalheira 35MM) | X | | 44 |
| CX.33114/2 | TOYOTA | Rep. CX. Toyota Hilux SW4 (96 A 04) (Cremalheira 35MM) | | | 44 |
| CX.33214 | KOYO PIT BULL | Rep. CX. Toyota Hilux SR5 / SW4 após 05 com coifas | X | | 45 |
| CX.33214/2 | KOYO | Rep. CX. Toyota Hilux SR5 / SW4 após 05 | | | 45 |
| CX.33215 | KOYO | Rep. CX. Toyota Hilux SR5 / SRV (Setor 32MM) | | | 44 |
| CX.33218 | ZF. 8053.698.218 | Rep. CX. Toyota Bandeirantes | | | 38 |
| CX.33232 | KOYO | Rep. CX. Toyota Corolla / Matrix (02 a 07) com coifas | X | | 53 |
| CX.33232/2 | KOYO | Rep. CX. Toyota Corolla / Matrix (02 a 07) | | | 53 |
| CX.33236 | KOYO | Rep. CX. Toyota Corolla (93 a 01) Caixa Bi-Partida com coifa | X | | 53 |
| CX.33236/2 | KOYO | Rep. CX. Toyota Corolla (93 a 01) Caixa Bi-Partida | | | 53 |
| CX.33237 | KOYO | Rep. CX. Toyota Corolla (96 a 01) / RAV4 (96 a 03) Cx. Inteiriça c/ coifa | X | | 53 |
| CX.33237/2 | KOYO | Rep. CX. Toyota Corolla (96 a 01) / RAV4 (96 a 03) Caixa Inteiriça | | | 53 |
| CX.33239 | CX. ZF | Rep. CX. Toyota Corona (96 a 00) CX. ZF | X | | 53 |
| CX.33239/2 | CX. ZF | Rep. CX. Toyota Corona (96 a 00) CX. ZF | | | 53 |
| CX.33240/2 | KOYO | Rep. CX. Toyota Camry (02 a 06) | | | 53 |
| CX.33242/2 | KOYO | Rep. CX. Toyota Camry (91 a 01) / Avalon (00 a 04) | | | 53 |
| CX.33243/2 | KOYO | Rep. CX. Toyota Camry 07... | | | 53 |
| CX.33244/2 | KOYO | Rep. CX. Toyota Paseo (93 a 97) | | | 53 |
| CX.33245/2 | KOYO | Rep. CX. Toyota RAV4 (04 a 05) (Cremalheira 25,5MM) | | | 53 |

Troller

| Cód. AGEL | Ref. Mercado | Aplicação | Coifas | Buchas | Página |
|-----------|------------------|---------------------|--------|--------|--------|
| CX.33210 | ZF. 8053.698.210 | Rep. CX. Troller T4 | | | 35 |
| CX.33251 | ZF. 8052.698.251 | Rep. CX. Troller T4 | | | 35 |

Volkswagen (+)

| Cód. AGEL | Ref. Mercado | Aplicação | Coifas | Buchas | Página |
|------------|-------------------|---|--------|--------|--------|
| CX.22001 | ZF. 7683.698.001 | Rep. BBA. 12.140 / 16.170 / Ônibus 16-180 / VW 7/8T FN4 | | | 46 |
| CX.22002 | ZF. 7683.698.002 | Rep. BBA. LT7 / 8T FN3 | | | 40 |
| CX.22003 | BOMBA TC 17MM | Rep. BBA. Bora 98... / Golf 99... / New Beetle 98... | | | 33 |
| CX.22022 | ZF. 7673.698.022 | Rep. BBA. E21 / 1400 DT - Caminhões até 83 | | | 33 |
| CX.22032 | ZF. 7673.698.032 | Rep. BBA. 26.170 / 13.130 / 7.110S / 7.90S | | | 46 |
| CX.22044 | ZF. 7672.698.044 | Rep. BBA. 11.130 / 13.130 - Caminhões até 83 | | | 44 |
| CX.22050 | ZF. 7612.298.800 | Rep. BBA. Polo / Fox após 2003 (ZF / KYB) | | | 54 |
| CX.22053 | ZF. KYB Importada | Rep. BBA. ZF/KYB Space Fox G5 / após 10... Importado | | | 54 |
| CX.22103 | BOMBA TC 19MM | Rep. BBA. Golf / Passat / Variant (95 a 98) / Polo (97 a 98) | | | 34 |
| CX.22176 | ZF. 7672.698.176 | Rep. BBA. 11.130 / 13.130 Caminhões após 84 | | | 34 |
| CX.22194 | ZF. 7671.698.194 | Rep. BBA. Santana / Quantum | | | 37 |
| CX.22207 | ZF. 7674.698.207 | Rep. BBA. 13.210 / 15.210 | | | 37 |
| CX.22208 | ZF. 7673.698.208 | Rep. BBA. 13.130 / 14.200 - 7.90 / 7.110 | | | 44 |
| CX.22249 | ZF. 7691.698.249 | Rep. BBA. Golf (95 a 98) / Santana / Quantum 93... Rep. BBA. Logus / Pointer / (93 a 96) / Passat / Variant (Alemão 95 a 98) | | | 34 |
| CX.22304 | DHB. 1.804.304 | Rep. BBA. Gol / Parati / Voyage / Saveiro / Apolo 90 a 92 Rep. BBA. Logus / Pointer 93 a 96 / Santana / Quantum 96 a 98 | | | 34 |
| CX.22800 | ZF. 7683.298.800 | Rep. BBA. MWM 4.07 | | | 34 |
| CX.33014/2 | ZF. 7852.633.026 | Rep. CX. Passat / Variant 98... | | | 32 |
| CX.33020/2 | ZF. 7852.633.014 | Rep. CX. Eurovan / Caravelle | | | 44 |
| CX.33030 | ZF. 8058.698.030 | Rep. CX. 11.130 / 13.130 - 13.210 / 14.210 | | | 38 |
| CX.33033 | DHB. 1.804.033 | Rep. CX. Gol / Parati / Saveiro após 95... | X | | 44 |

(+) Volkswagen (+)

| Cód. AGEL | Ref. Mercado | Aplicação | Coifas | Buchas | Página |
|------------|------------------|---|--------|--------|--------|
| CX.33033/2 | DHB. 1.804.033 | Rep. CX. Gol / Parati / Saveiro após 95... | | | 44 |
| CX.33060 | ZF. 8058.698.031 | Rep. Sem Fim 11.130 / 13.130 - 13.210 / 14.210 | | | 38 |
| CX.33101 | ZF. 8053.698.013 | Rep. Sem Fim 11.130 / 13.130 | | | 35 |
| CX.33105 | TRINTER | Rep. CX. Gol / Parati / Saveiro / Voyage após 95 | X | X | 44 |
| CX.33105/2 | TRINTER | Rep. CX. Gol / Parati / Saveiro / Voyage após 95 | | X | 44 |
| CX.33106 | TRW. ITALIANA | Rep. CX. Golf Antiga / Variant (95 a 98) Alemão/Van (Furgão 98...) | X | | 43 |
| CX.33106/2 | TRW. ITALIANA | Rep. CX. Golf Antiga / Variant (95 a 98) Alemão/Van (Furgão 98...) | | | 43 |
| CX.33195 | ZF. 7881.698.195 | Rep. CX. Santana / Quantum (85 a 91) | X | | 44 |
| CX.33195/2 | ZF. 7881.698.195 | Rep. CX. Santana / Quantum (85 a 91) | | | 44 |
| CX.33224 | ZF | Rep. CX. Golf / Passat / Variant 95 a 98 com coifas | X | | 54 |
| CX.33224/2 | ZF | Rep. CX. Golf / Passat / Variant 95 a 98 | | | 54 |
| CX.33225 | DHB. 1.804.225 | Rep. CX. Gol / Parati / Saveiro até 94 (Válvula Alumínio) | X | | 44 |
| CX.33225/2 | DHB. 1.804.225 | Rep. CX. Gol / Parati / Saveiro até 94 (Válvula Alumínio) | | | 44 |
| CX.33226 | ZF. 8097.698.226 | Rep. CX. Servocom - 16.170 a 40.430 (Tampas de Plástico) Rep. CX. Constellation 17.260 a 31.360 (Tampas de Plástico) | | | 37 |
| CX.33238 | ZF. 7881.698.238 | Rep. CX. Santana / Quantum (91 a 96) | X | | 38 |
| CX.33238/2 | ZF. 7881.698.238 | Rep. CX. Santana / Quantum (91 a 96) | | | 38 |
| CX.33248 | KOYO SMI | Rep. CX. Passat Alemão após 00 (08281253) | X | | 54 |
| CX.33248/2 | KOYO SMI | Rep. CX. Passat Alemão após 00 (0828125) 8DI422072 | | | 54 |
| CX.33255 | ZF. 8090.698.255 | Rep. CX. 8-140 CO / 8-150 OD / 9-150 OD | | | 46 |
| CX.33319 | REP CX. TRW | Gol G5 / Voyage após 09... com coifas | X | X | 54 |
| CX.33319/2 | REP CX. TRW | Gol G5 / Voyage após 09... sem coifas | | X | 54 |
| CX.33750 | TRW. 16.150.750 | Rep. CX. Logus / Pointer (93 a 96) | X | X | 39 |
| CX.33750/2 | TRW. 16.150.750 | Rep. CX. Logus / Pointer (93 a 96) | | X | 39 |
| CX.33752 | TRW. 16.150.752 | Rep. CX. Gol / Parati / Saveiro / Voyage após 95 | X | | 44 |
| CX.33752/2 | TRW. 16.150.752 | Rep. CX. Gol / Parati / Saveiro / Voyage após 95 | | | 44 |
| CX.33754 | TRW. 16.150.754 | Rep. CX. Santana / Quantum após 93 | X | | 38 |
| CX.33754/2 | TRW. 16.150.754 | Rep. CX. Santana / Quantum após 93 | | | 38 |

(+) Volkswagen

| Cód. AGEL | Ref. Mercado | Aplicação | Coifas | Buchas | Página |
|------------|-----------------------|---|--------|--------|--------|
| CX.33771 | TRW. 22.150.771 | Rep. CX. 7100 a 8140 - TAS-30305 - (TAS-30) | | | 38 |
| CX.33775 | TRW. 22.150.775 | Rep. CX. 11.140 a 14.170 (TAS-65) com junta | | | 39 |
| CX.33775/3 | TRW. 22.150.775 | Rep. CX. 11.140 a 14.170 (TAS-65) sem junta | | | 39 |
| CX.33805 | ZF. 8090.298.805 | Rep. CX. Servocom Completo 8090.298.805 | | | 54 |
| CX.33810 | ZF. 8097.298.810 | Rep. CX. Servocom - 16.170 a 40.430 (Tampas de Borracha) Rep. CX. Constellation 17.260 a 31.360 (Tampas de Borracha) | | | 38 |
| CX.33927 | REP. CX. JTEKT / KOYO | Gol G5 com coifa | X | X | 54 |
| CX.33927/2 | REP. CX. JTEKT / KOYO | Gol G5 sem coifa | | X | 54 |
| CX.33928 | KOYO - 7750000013 | Rep. CX. Fox / Polo (Após 03) / Gol após 09 GV | X | X | 44 |
| CX.33928/2 | KOYO - 7750000013 | Rep. CX. Fox / Polo (Após 03) / Gol após 09 GV | | X | 44 |
| CX.33953 | ZF. 7891.633.501 | Rep. CX. Bora 98... / Golf 99 ... / New Beetle 98... | X | X | 33 |
| CX.33953/2 | ZF. 7891.633.501 | Rep. CX. Bora 98... / Golf 99 ... / New Beetle 98... | | X | 33 |
| CX.33954/2 | KOYO / SMI | Rep. CX. Passat / Variant (Alemão) após 99 | | | 47 |
| CX.33956 | ZF. CORDOBA IBIZA | Rep. CX. ZF. Cordoba Ibiza até 99 com coifa | X | | 54 |
| CX.33956/2 | ZF. CORDOBA IBIZA | Rep. CX. ZF. Cordoba Ibiza até 99 | | | 54 |
| CX.33957 | ZF. 7691.633.506 | Rep. CX. Golf 2010... com coifas (bucha sem retentor) | X | X | 54 |
| CX.33957/2 | ZF. 7691.633.506 | Rep. CX. Golf 2010... sem coifas (bucha sem retentor) | | X | 54 |
| CX.33958 | ZF. 7853.974.562 | Rep. CX. Amarok 2008... 2H1 422 055 C | X | X | 54 |
| CX.33958/2 | ZF. 7853.974.562 | Rep. CX. Amarok 2008... 2H1 422 055 C | | X | 54 |

Volvo (+)

| Cód. AGEL | Ref. Mercado | Aplicação | Coifas | Buchas | Página |
|-----------|------------------|--|--------|--------|--------|
| CX.22018 | ZF. 7673.698.018 | Rep. BBA. B58 / N10 / N12 | | | 44 |
| CX.22019 | ZF. 8695.633.003 | Rep. BBA. Volvo FH400/420/440/FM 8x4 (Cód.BBA. 8694.974.514/521) | | | 54 |
| CX.22104 | LUK. 543.0035.10 | Rep. BBA. LUK FH12 | | | 43 |
| CX.22801 | ZF. 7683.298.801 | Rep. BBA. F12 / NH12 / FM12 | | | 37 |
| CX.33017 | ZF. 8065.698.017 | Rep. CX. B58 | | | 37 |

(+) Volvo

| Cód. AGEL | Ref. Mercado | Aplicação | Coifas | Buchas | Página |
|------------|------------------|--|--------|--------|--------|
| CX.33043/2 | TRW | Rep. CX. Volvo 240 (79 a 88) / 260 (79 a 88) / 340 (75 a 91) / 960 (91 a 97) Rep. CX. 360 (75 a 91) / 440 (86 a 96) / 460 (86 a 96) / 480 (86 a 96) Rep. CX. 740 (82 a 92) / 760 (82 a 92) / 850 (91 a 96) / 940 (91 a 94) Rep. CX. S70 após 97 / S90 após 98 / V70 após 97 / V90 após 97 | | | 44 |
| CX.33057 | ZF. 8043.698.057 | Rep. CX. Volvo N10 / N12 / B10 M | | | 44 |
| CX.33058/2 | SMI / KOYO | Rep. CX. Volvo S70 / V70 (98 a 00) / 850 (93 a 97) | | | 54 |
| CX.33226 | ZF. 8097.698.226 | Rep. CX. Servocom - B10M / B12B / NL10 / NL12 (Tampas de Plástico) | | | 37 |
| CX.33810 | ZF. 8097.298.810 | Rep. CX. Servocom (Todos 8097) Tampas de Borracha | | | 38 |
| CX.33811 | ZF. 8098.298.800 | Rep. CX. FM12 / FH12 / NH12 / FH400 / FM420 / FH440 | | | 40 |

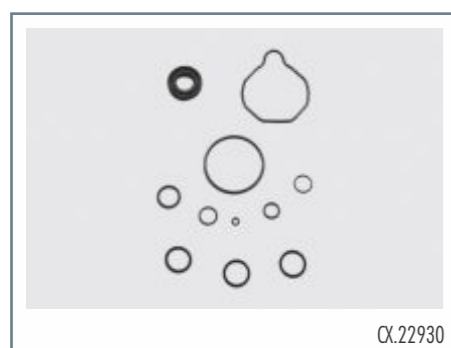

CX.22930

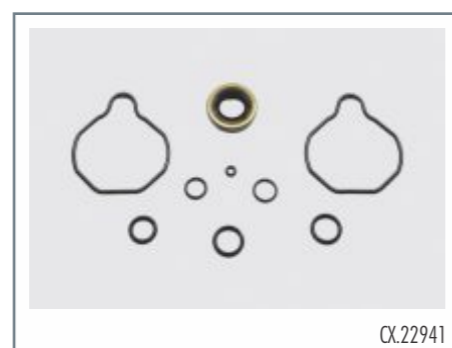

CX.22941



CX.33246/2



CX.22700



CX.33010 e CX.33010/2 (sem coifas)



CX.33014/2

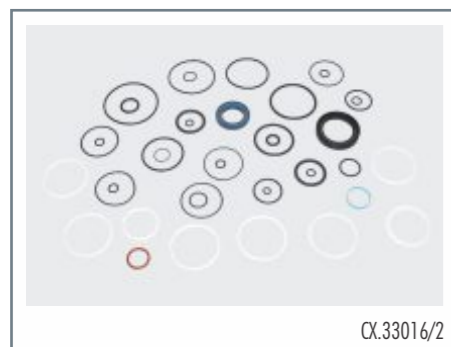

CX.33016/2

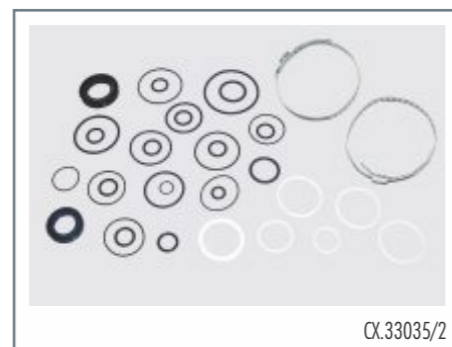

CX.33035/2



CX.33096



CX.33953 e CX.33953/2 (sem coifas)

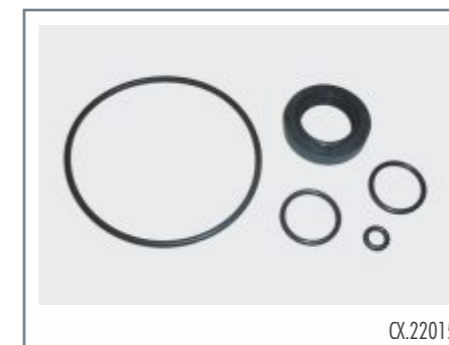

CX.22015



CX.22958



CX.33008/2



CX.33009/2



CX.33011 e CX.33011/2



CX.33025/2



CX.33092



CX.33094/2



CX.22080

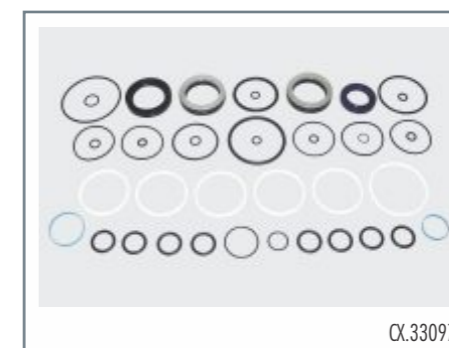

CX.33097



CX.22003



CX.22028



CX.22022



CX.22023



CX.22090



CX.22249

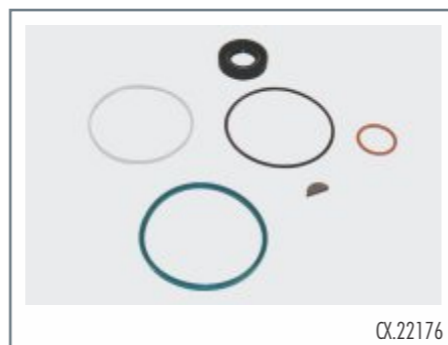

CX.22176



CX.33070 e CX.33070/2 (sem coifas)



CX.33071 e CX.33071/2 (sem coifas)



CX.33143 e CX.33143/2 (sem coifas)



CX.22107



CX.22103



CX.22077



CX.33062/2



CX.33100 e CX.33100/2 (sem coifas)



CX.33112 e CX.33112/2 (sem coifas)



CX.22304

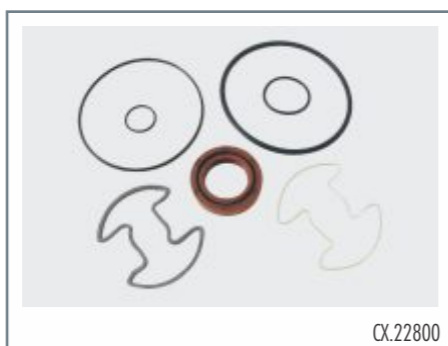

CX.22800



CX.33012 e CX.33012/2 (sem coifas)



CX.33130



CX.33210



CX.33251



CX.33013/2



CX.33122



CX.33169 e CX.33169/2 (sem coifas)



CX.33015

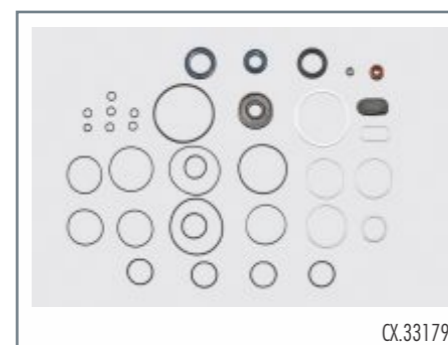

CX.33179



CX.33235



CX.33827 e CX.33827/2 (sem coifas)



CX.33031



CX.33049 e CX.33049/2 (sem coifas)



CX.33101



CX.33107 e CX.33107/2 (sem coifas)

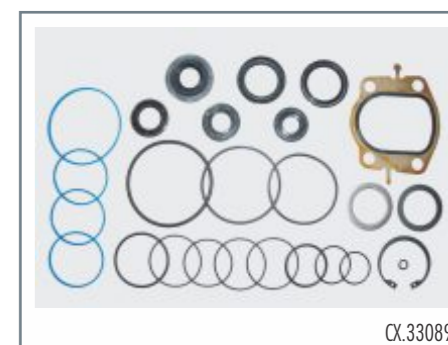

CX.33089



CX.33090



CX.33108



CX.22054



CX.33111 e CX.33111/2 (sem coifas)



CX.33758 e CX.33758/2 (sem coifas)



CX.33760 e CX.33760/2 (sem coifas)



CX.33147/2



CX.22802



CX.33150



CX.33844 e CX.33844/2 (sem coifas)



CX.33940 e CX.33940/2 (sem coifas)



CX.33736 e CX.33736/2 (sem coifas)



CX.33153



CX.33156 e CX.33156/2 (sem coifas)



CX.22101



CX.33017



CX.33199 e CX.33199/2 (sem coifas)



CX.22029



CX.33085

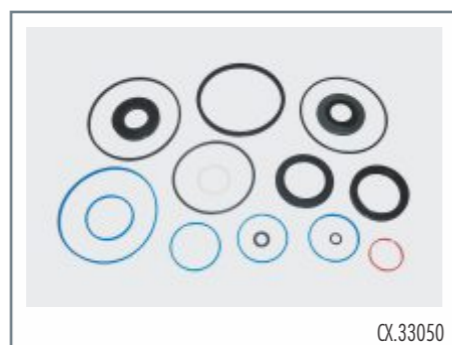

CX.33050



CX.33149/2

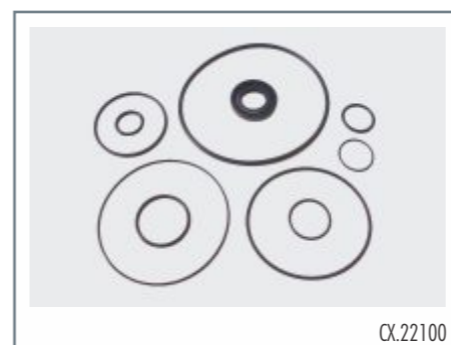

CX.22100



CX.22207

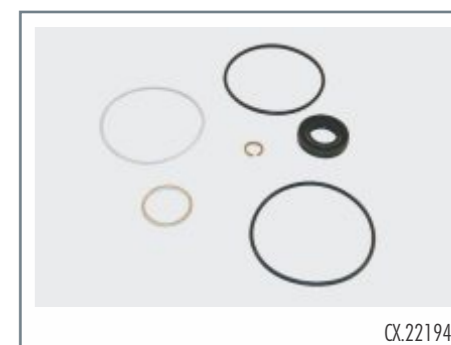

CX.22194



CX.33849 e CX.33849/2 (sem coifas)



CX.33109 e CX.33109/2 (sem coifas)



CX.33110 e CX.33110/2 (sem coifas)



CX.22801



CX.33186



CX.33226



CX.33810



CX.33030



CX.33060



CX.33775 e CX.33775/3 (sem junta)



CX.33750 e CX.33750/2 (sem coifas)



CX.33764



CX.33095



CX.33151/2



CX.33165 e CX.33165/2 (sem coifas)



CX.33119 e CX.33119/2 (sem coifas)



CX.33200 e CX.33200/2 (sem coifas)



CX.33220/2



CX.33230



CX.33231



CX.33055



CX.33221/2



CX.33102



CX.33103 e CX.33103/2 (sem coifas)



CX.33075 e CX.33075/2 (sem coifas)



CX.33238 e CX.33238/2 (sem coifas)



CX.33218



CX.33121 e CX.33121/2 (sem coifas)



CX.33104 e CX.33104/2 (sem coifas)



CX.33914 e CX.33914/2 (sem coifas)



CX.33206 e CX.33206/2 (sem coifas)



CX.33754 e CX.33754/2 (sem coifas)



CX.33771



CX.33924



CX.33850 e CX.33850/2 (sem coifas)



CX.22300



CX.33935



CX.33811



CX.33146



CX.33080



CX.33081



CX.33082/2



CX.33072 e CX.33072/2 (sem coifas)



CX.33938



CX.33905



CX.33083/2



CX.33610 e CX.33610/2 (sem coifas)



CX.33611 e CX.33611/2 (sem coifas)



CX.33182/2



CX.33183 e CX.33183/2 (sem coifas)



CX.22105



CX.33612 e CX.33612/2 (sem coifas)

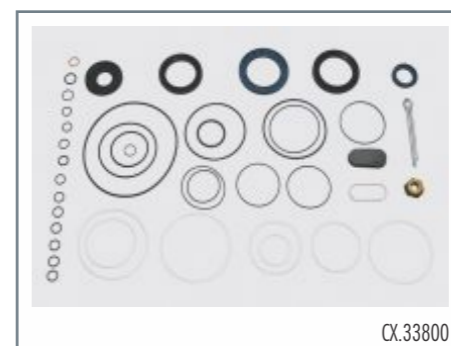

CX.33800



CX.33900



CX.22030



CX.22002



CX.22263



CX.33180



CX.33061



CX.33007

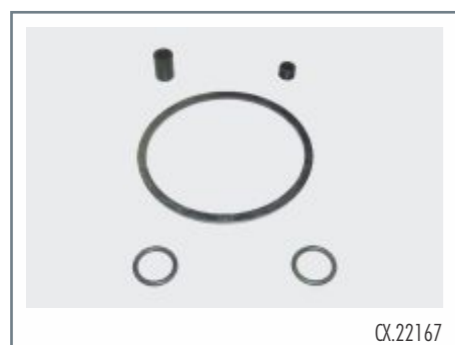

CX.22167



CX.22811



CX.33005



CX.33170



CX.33002



CX.33261



CX.22010

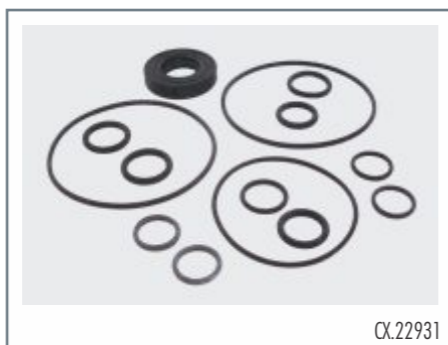

CX.22931



CX.33160/2



CX.33126 e CX.33126/2 (sem coifas)



CX.33137 e CX.33137/2 (sem coifas)



CX.33140 e CX.33140/2 (sem coifas)



CX.33931

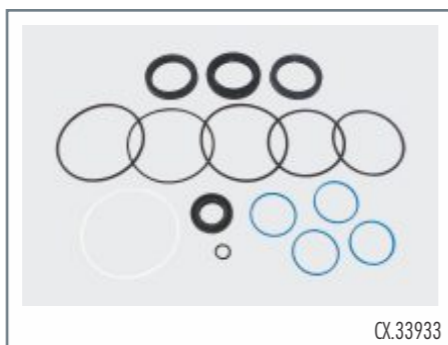

CX.33933



CX.33117 e CX.33117/2 (sem coifas)



CX.22034



CX.22035



CX.22104



CX.33926/2



CX.33929



CX.33968



CX.33943 e CX.33943/2



CX.33068

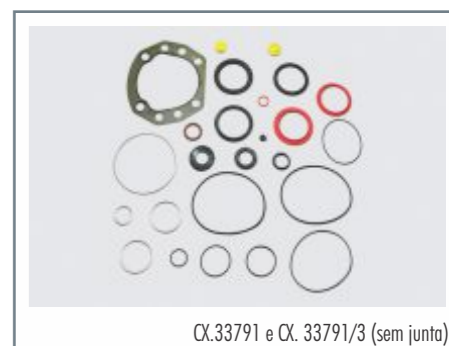

CX.33791 e CX.33791/3 (sem junta)



CX.33115 e CX.33115/2 (sem coifas)



CX.33120



CX.33172 e CX.33172/2 (sem coifas)

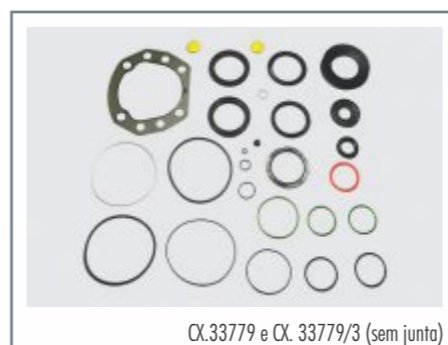

CX.33779 e CX.33779/3 (sem junta)



CX.33106 e CX.33106/2 (sem coifas)



CX.33044 e CX.33044/2 (sem coifas)



CX.33175/2



CX.33118 e CX.33118/2 (sem coifas)



CX.33125 e CX.33125/2 (sem coifas)

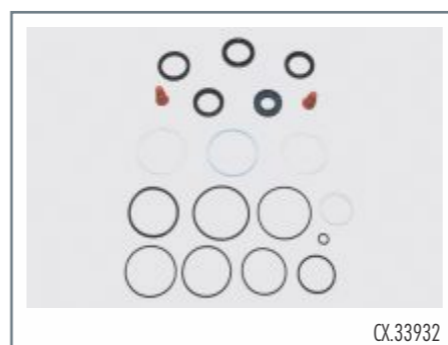

CX.33932



CX.22600



CX.33113

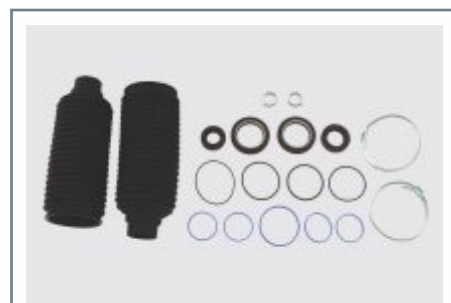

CX.33114 e CX.33114/2 (sem coifas)

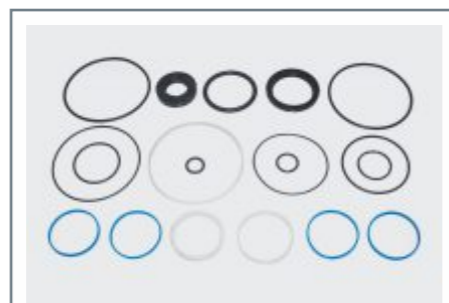

CX.33215



CX.22044

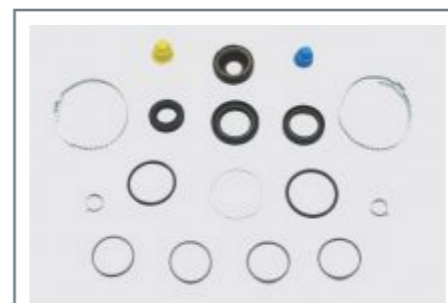

CX.33144/2



CX.33222 e CX.33222/2 (sem coifas)



CX.33279/2



CX.22208



CX.33195/2



CX.33225 e CX.33225/2 (sem coifas)



CX.33915 e CX.33915/2 (sem coifas)



CX.33504 e CX.33504/2 (sem coifas)



CX.33512 e CX.33512/2 (sem coifas)



CX.33020/2



CX.33033 e CX.33033/2 (sem coifas)



CX.33105 e CX.33105/2 (sem coifas)



CX.33904



CX.33142/2

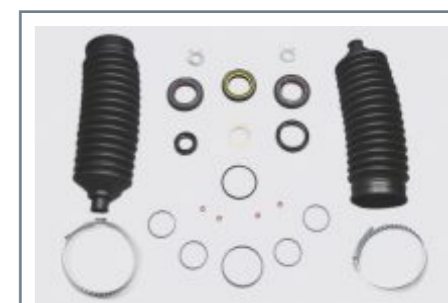

CX.33214 e CX.33214/2 (sem coifas)



CX.33752 e CX.33752/2 (sem coifas)



CX.33928 e CX.33928/2 (sem coifas)



CX.22018



CX.33166 e CX.33166/2 (sem coifas)



CX.33167 e CX.33167/2 (sem coifas)



CX.33168 e CX.33168/2 (sem coifas)



CX.33043/2



CX.33057



CX.33152

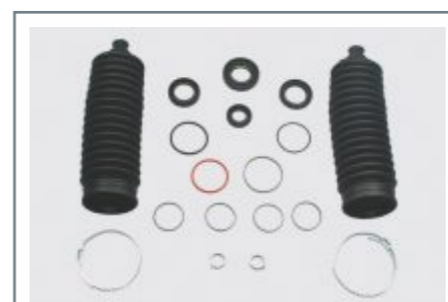

CX.33503 e CX.33503/2 (sem coifas)

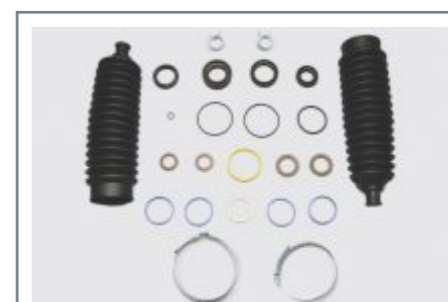

CX.33163 e CX.33163/2 (sem coifas)



CX.33173 e CX.33173/2 (sem coifas)



CX.22001



CX.33255



CX.22005



CX.33099



CX.33954/2

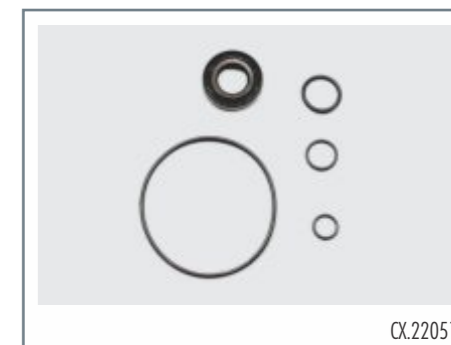

CX.22051



CX.33040 e CX.33040/2 (sem coifas)



CX.33042 e CX.33042/2 (sem coifas)



CX.33751/2

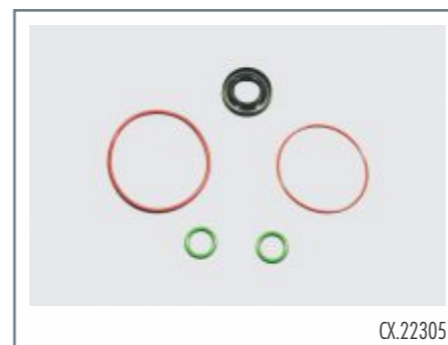

CX.22305



CX.33018

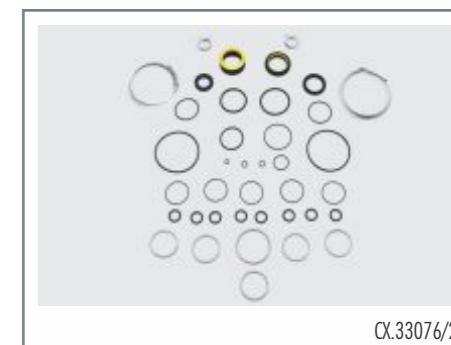

CX.33076/2



CX.33019



CX.33116 e CX.33116/2 (sem coifas)



CX.22004

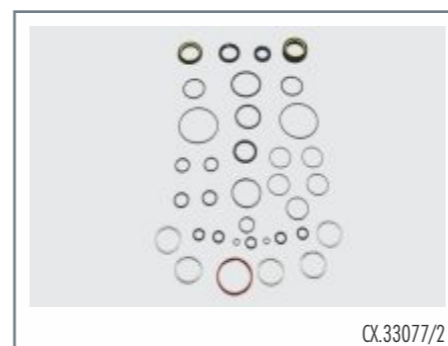

CX.33077/2

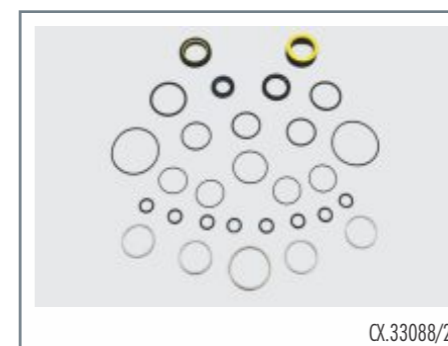

CX.33088/2

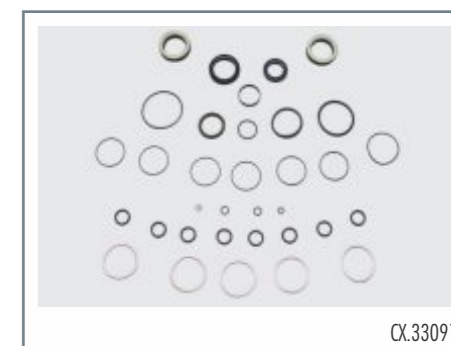

CX.33091



CX.22032



CX.33006



CX.33078/2

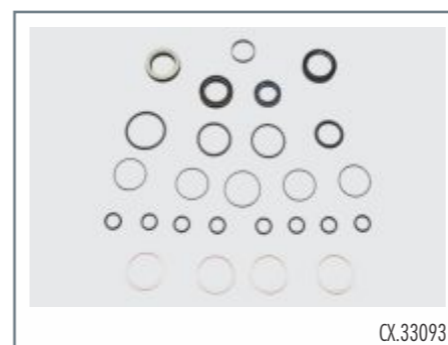

CX.33093



CX.33127 e CX.33127/2 (sem coifas)

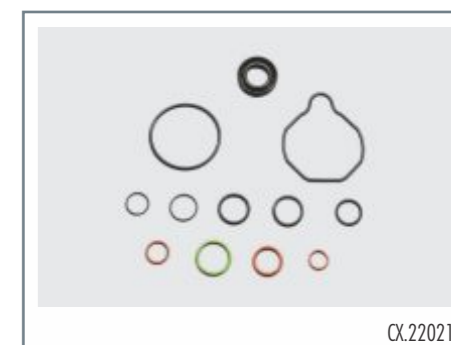

CX.22021



CX.33086/2

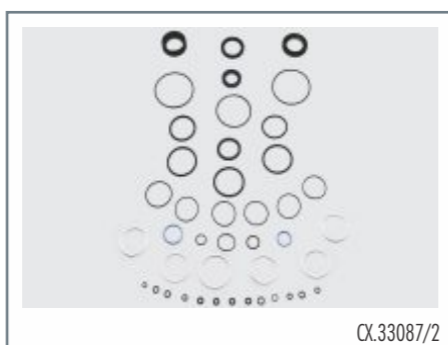

CX.33087/2



CX.33098

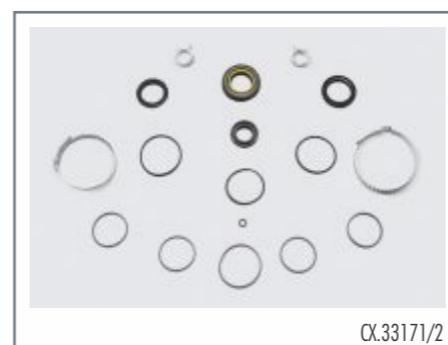

CX.33171/2



CX.33252/2



CX.33828 e CX.33828/2 (sem coifas)



CX.22932



CX.33145/2



CX.33148/2



CX.33917 e CX.33917/2 (sem coifas)



CX.33318 e CX.33318/2

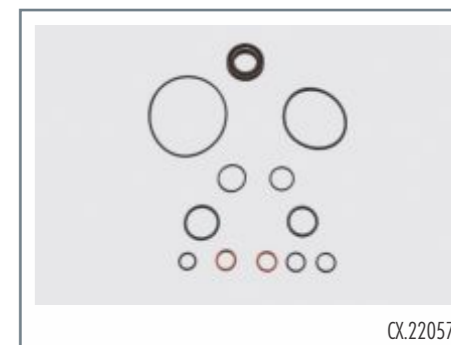

CX.22057



CX.33247/2 (sem coifas)



CX.22049



CX.33157



CX.22058



CX.33834/2



CX.33835/2



CX.22602



CX.33845 e CX.33845/2 (sem coifas)



CX.33847 e CX.33847/2 (sem coifas)



CX.33851 e CX.33851/2 (sem coifas)



CX.33852/2



CX.33853/2

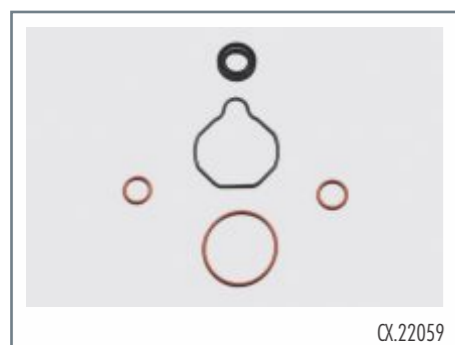

CX.22059



CX.33223 e CX.33223/2 (sem coifas)

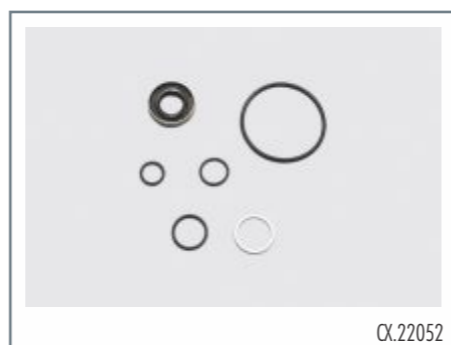

CX.22052

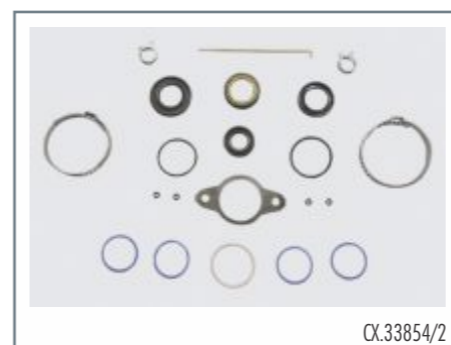

CX.33854/2



CX.33855/2



CX.33856 e CX.33856/2 (sem coifas)



CX.33164 e CX.33164/2 (sem coifas)



CX.33907 e CX.33907/2 (sem coifas)



CX.33916 e CX.33916/2 (sem coifas)



CX.33857 e CX.33857/2 (sem coifas)

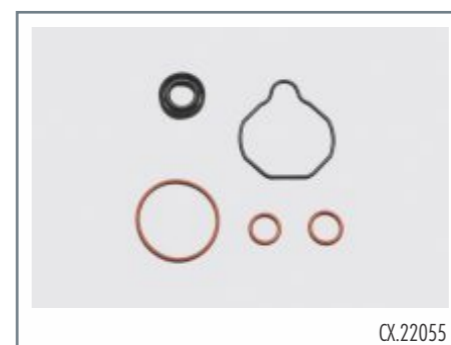

CX.22055

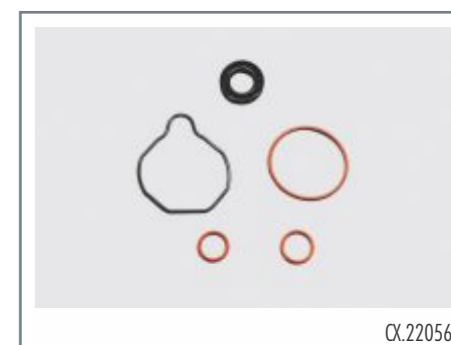

CX.22056

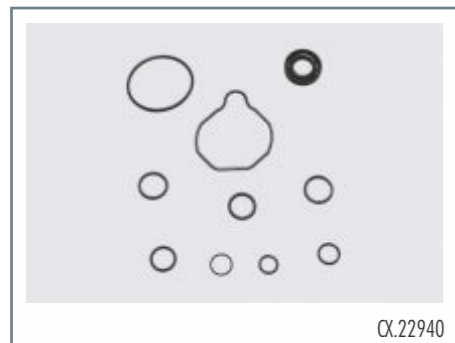

CX.22940

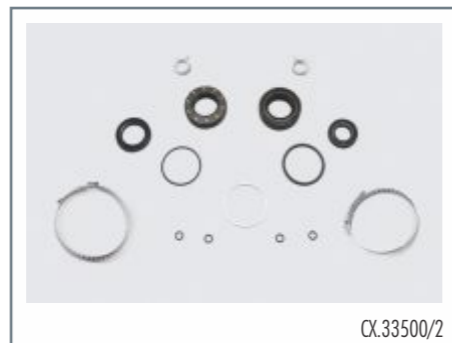

CX.33500/2

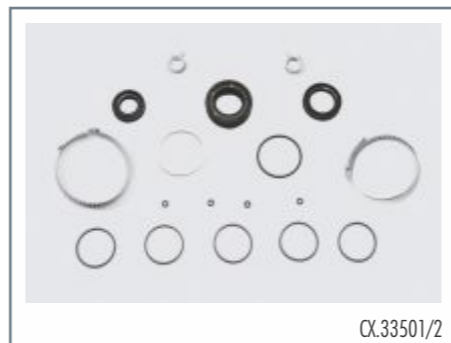

CX.33501/2



CX.33052

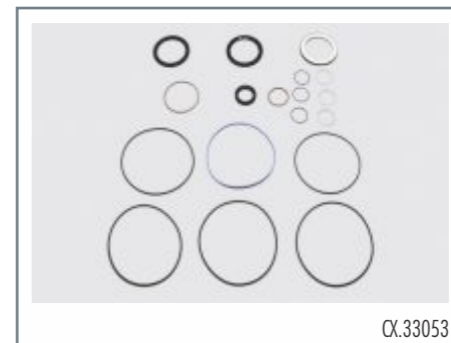

CX.33053

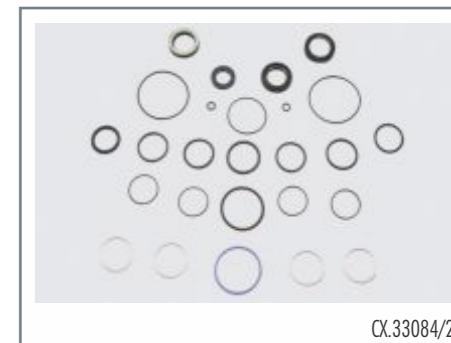

CX.33084/2



CX.33502 e CX.33502/2 (sem coifas)



CX.33506/2



CX.33507/2



CX.33865 e CX.33865/2 (sem coifas)

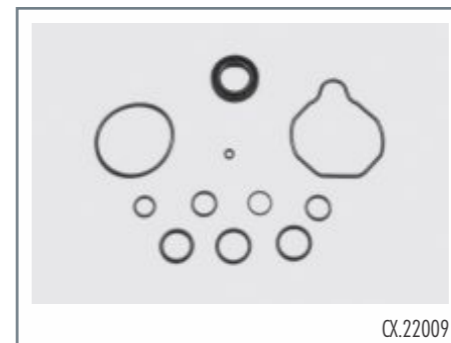

CX.22009

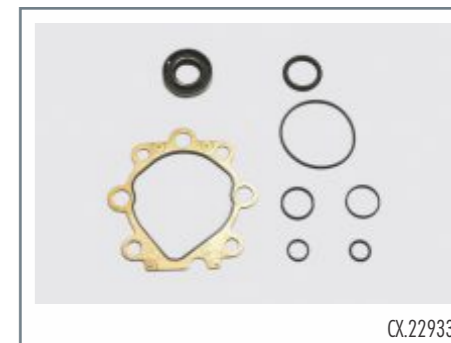

CX.22933



CX.33508/2



CX.33510/2



CX.33511/2



CX.33128/2

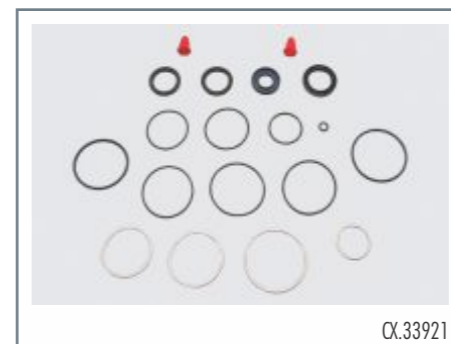

CX.33921



CX.33930/2



CX.33513 e CX.33513/2 (sem coifas)

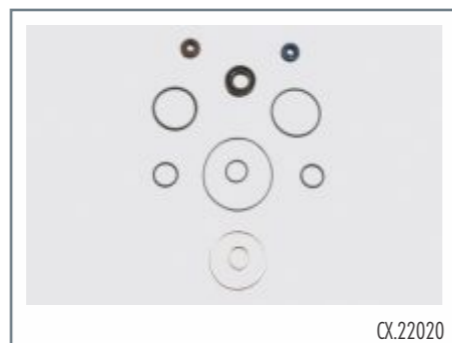

CX.22020

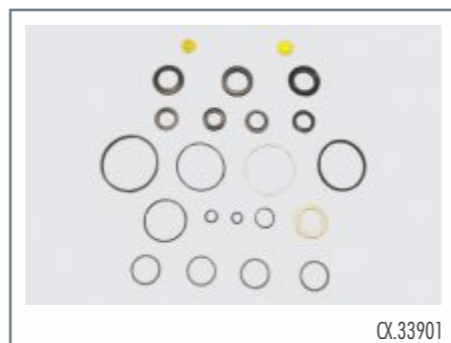

CX.33901



CX.33934 e CX.33934/2 (sem coifas)



CX.33936/2



CX.33937 e CX.33937/2 (sem coifas)

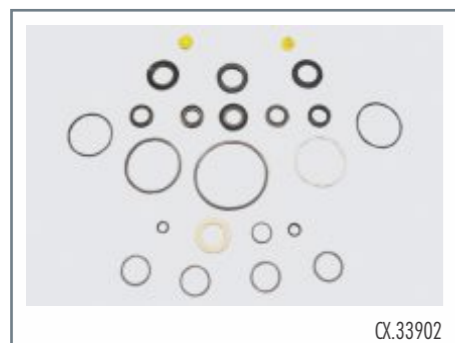

CX.33902

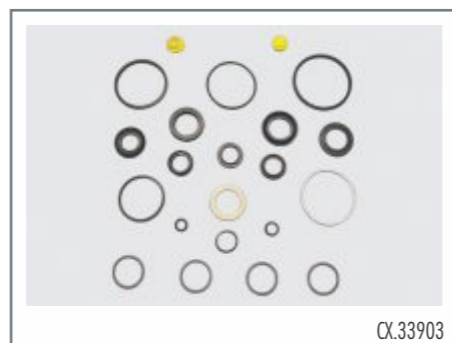

CX.33903



CX.33241 e CX.33241/2 (sem coifas)



CX.33939/2



CX.33941/2



CX.33942/2

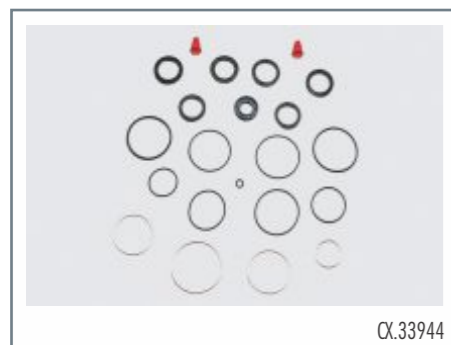

CX.33944



CX.33945 e CX.33945/2 (sem coifas)



CX.33967/2

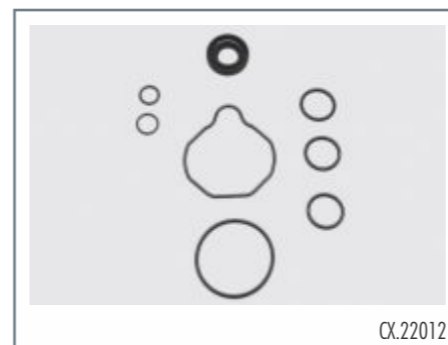

CX.22012

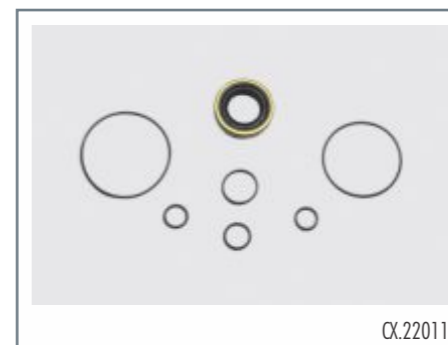

CX.22011

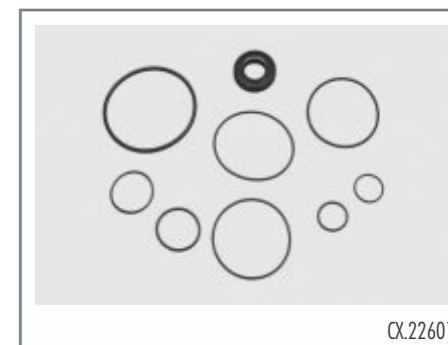

CX.22601

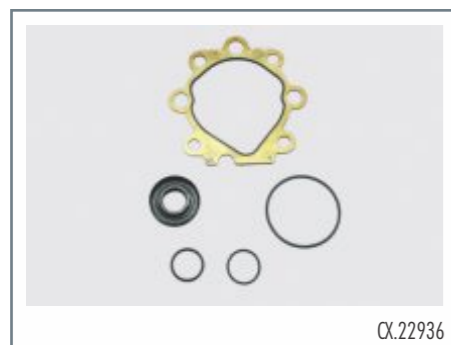

CX.22936



CX.33123 e CX. 33123/2 (sem coifas)



CX.33124 e CX. 33124/2 (sem coifas)

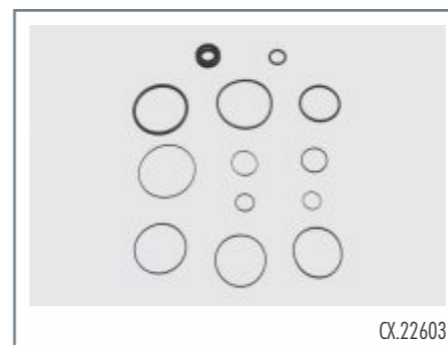

CX.22603

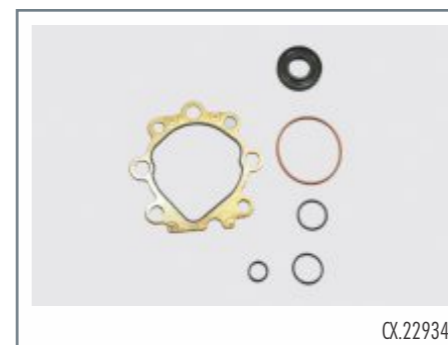

CX.22934

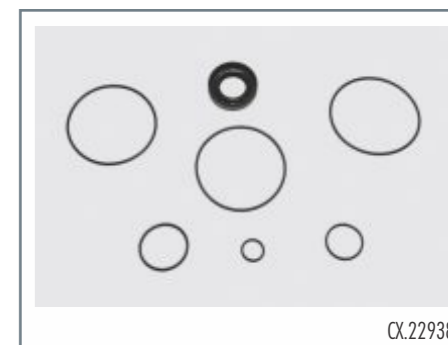

CX.22938



CX.33176 e CX. 33176/2 (sem coifas)



CX.33846 e CX. 33846/2 (sem coifas)



CX.33067



CX.33232 e CX.33232/2 (sem coifas)



CX.33236 e CX.33236/2 (sem coifas)



CX.33237 e CX.33237/2 (sem coifas)



CX.33141 e CX.33141/2 (sem coifas)



CX.33045/2



CX.33046/2



CX.33239 e CX.33239/2 (sem coifas)



CX.33240/2



CX.33242/2



CX.33047/2



CX.33048/2



CX.33059/2



CX.33243/2



CX.33244/2



CX.33245/2

Problemas X Causas

A análise de problemas e causas apresentadas na próxima página servem apenas como referência para determinadas análises. Apresentam um pouco da experiência de nossa equipe com o sistema de direção referente a determinadas falhas. Desta forma, a tabela passa a ser uma ferramenta "viva" e deve sofrer revisões sempre que necessário, para o que contamos com a sua contribuição.



Tabela para Ajustes de Eixos e Furos



TOLERÂNCIA ISO (ABNT) PARA AJUSTE DE EIXO

| Ø mm | D8 | D9 | D10 | E6 | E7 | E8 |
|---------|------------------|------------------|------------------|------------------|------------------|------------------|
| 10 - 18 | -0,050 -0,077 | -0,050 -0,093 | -0,050 -0,120 | -0,032 -0,043 | -0,032 -0,050 | -0,032 -0,059 |
| 18 - 30 | -0,065 -0,098 | -0,065 -0,117 | -0,065 -0,149 | -0,040 -0,053 | -0,040 -0,061 | -0,040 -0,073 |
| 30 - 50 | -0,080 -0,119 | -0,080 -0,142 | -0,080 -0,180 | -0,050 -0,068 | -0,050 -0,075 | -0,050 -0,089 |

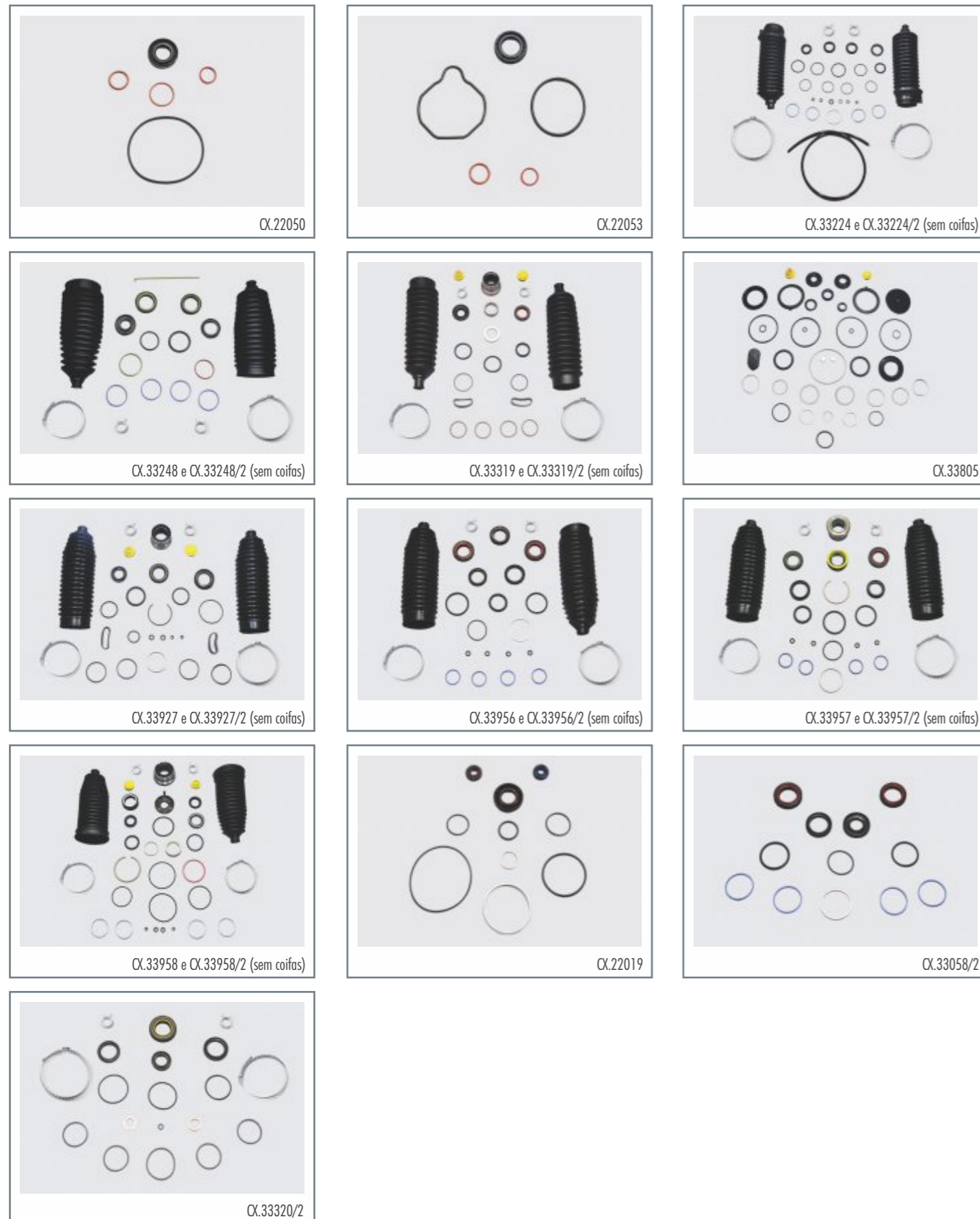
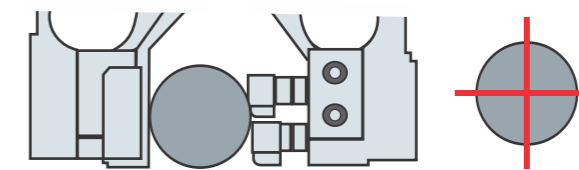
*Tabela e tolerância de acordo com as normas da ABNT

APC

A MARCA DA QUALIDADE

Quem entende de vedação, aprova APC kits e reparos.
Produzidos em nosso parque industrial com tecnologia de ponta,
garantem segurança e bem estar para o usuário,
variedade e qualidade de atendimento e pronta entrega
para o revendedor e praticidade para o montador.

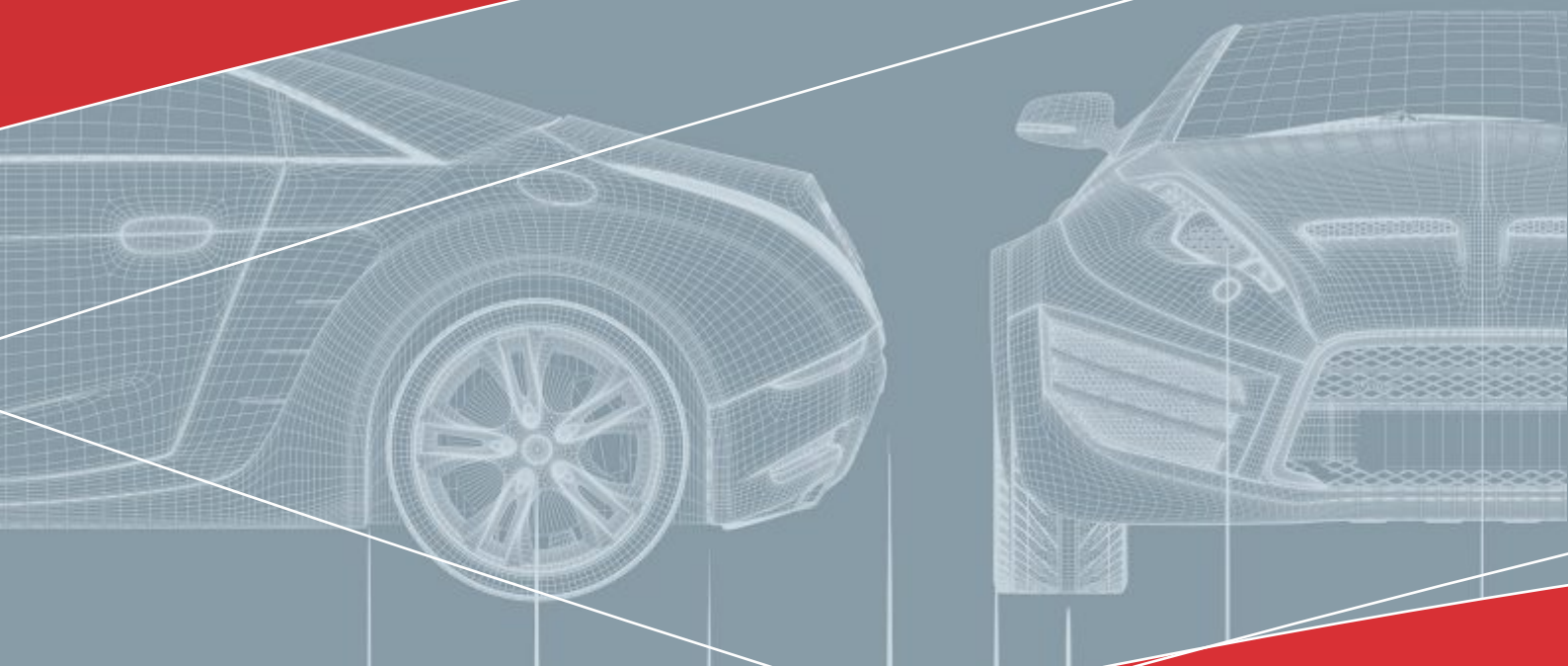

APC
A MARCA DA QUALIDADE

11 4133.2000 - vendas@agel.com.br - www.agel.com.br